

# Varde Anholt Varde Bornholm Varde Fur Varde Langeland Varde Femø Varde Bogø

## Installation— and User guide

Revision 2

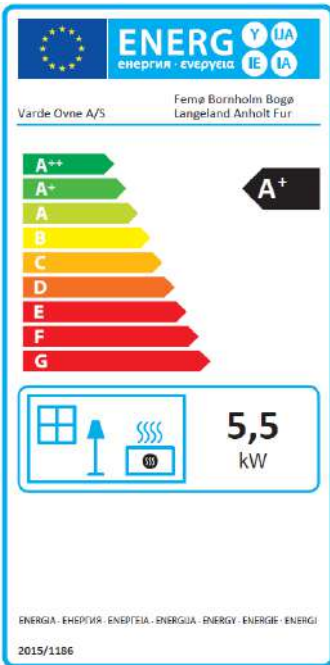

Soldalen 12, 7100 Vejle, Danmark, Tel. +45 7482 0003. [vardeovne.dk](http://vardeovne.dk)

# Congratulation on purchasing your new stove

Varde Ovne A/S is a Danish company specializing in functional, environmentally friendly and designed quality stoves.

## Index

|                                    |         |
|------------------------------------|---------|
| Welcome and index                  | Page 2  |
| Technical specifications Anholt    | Page 3  |
| Technical specifications Bornholm  | Page 4  |
| Technical specifications Fur       | Page 5  |
| Technical specifications Langeland | Page 6  |
| Technical specifications Femø      | Page 7  |
| Technical specifications Bogø      | Page 8  |
| Regulations and approval           | Page 9  |
| Flooring and distance              | Page 10 |
| Installations distances            | Page 11 |
| Chimney                            | Page 12 |
| Air supply                         | Page 13 |
| How to light and stoke a fire      | Page 14 |
| How to light and stoke a fire      | Page 15 |
| Operation                          | Page 16 |
| Vermiculite                        | Page 17 |
| How to choose the wood             | Page 18 |
| Maintenance                        | Page 19 |
| Troubleshooting                    | Page 20 |
| Spare parts                        | Page 21 |
| Testcertificate (RRF)              | Page 22 |
| Warranty                           | Page 23 |

### Technical Specification Anholt

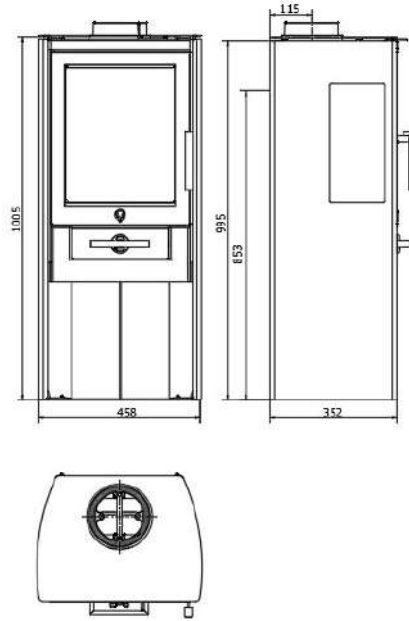

#### Model Anholt

|                |                      |
|----------------|----------------------|
| Height (mm)    | 1005                 |
| Wide (mm)      | 458                  |
| Depth (mm)     | 352                  |
| Weight (kg)    | 85                   |
| Effect         | 3-7 kW               |
| Nominal Output | 5,5 kW               |
| Heated area    | 30-105m <sup>2</sup> |
| Efficiency     | 80 %                 |
| EEl            | 107                  |
| Flue gas data  | 273°C at 25°C, 12Pa. |

Combustion Chamber : (H x W x D):  
245-360/300/280mm

Flue outlet:  
Ø 15cm (Mounting height top: 99cm)

Distance to non inflammable:  
5-10cm (Recommended)

Distance to inflammable wall and materials:  
Rear = 30cm, Sides = 45cm, In front = 110cm



## Technical Specification Bornholm

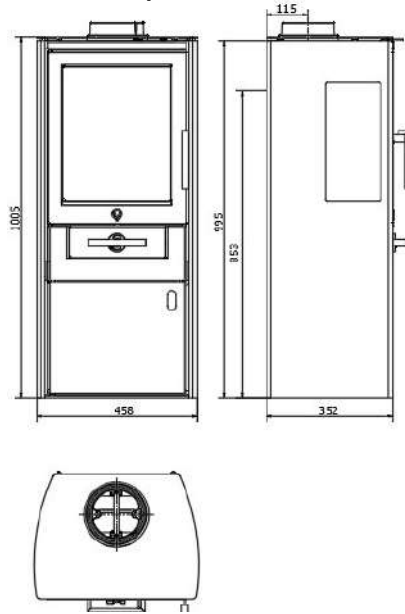

### Model Bornholm

|                |                      |
|----------------|----------------------|
| Height (mm)    | 1005                 |
| Wide (mm)      | 458                  |
| Depth (mm)     | 352                  |
| Weight (kg)    | 85                   |
| Effect         | 3-7 kW               |
| Nominal Output | 5,5 kW               |
| Heated area    | 30-105m <sup>2</sup> |
| Efficiency     | 80 %                 |
| EEl            | 107                  |
| Flue gas data  | 273°C at 25°C, 12Pa. |

Combustion Chamber : (H x W x D):  
245-360/300/280mm

Flue outlet:  
Ø 15cm (Mounting height top: 99cm)

Distance to non inflammable:  
5-10cm (Recommended)

Distance to inflammable wall and materials:  
Rear = 30cm, Sides = 45cm, In front = 110cm

## Technical Specification Fur

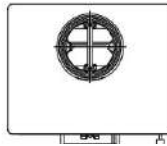
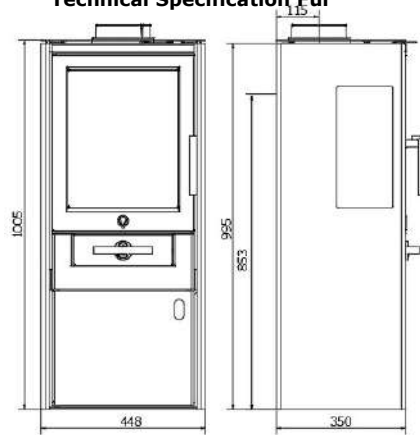

### Model Fur

|                |                      |
|----------------|----------------------|
| Height (mm)    | 1005                 |
| Wide (mm)      | 448                  |
| Depth (mm)     | 350                  |
| Weight (kg)    | 85                   |
| Effect         | 3-7 kW               |
| Nominal Output | 5,5 kW               |
| Heated area    | 30-105m <sup>2</sup> |
| Efficiency     | 80 %                 |
| EEI            | 107                  |
| Flue gas data  | 273°C at 25°C, 12Pa. |

Combustion Chamber : (H x W x D):  
245-360/300/280mm

Flue outlet:  
Ø 15cm (Mounting height top: 99cm)

Distance to non inflammable:  
5-10cm (Recommended)

Distance to inflammable wall and materials:  
Rear = 30cm, Sides = 45cm, In front = 110cm

## Technical Specification Langeland

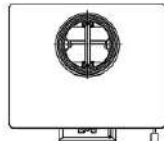
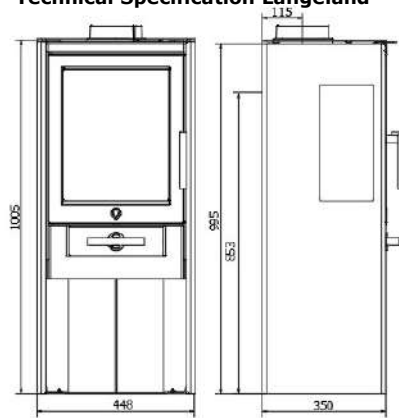

### Model Langeland

|                |                      |
|----------------|----------------------|
| Height (mm)    | 1005                 |
| Wide (mm)      | 448                  |
| Depth (mm)     | 350                  |
| Weight (kg)    | 85                   |
| Effect         | 3-7 kW               |
| Nominal Output | 5,5 kW               |
| Heated area    | 30-105m <sup>2</sup> |
| Efficiency     | 80 %                 |
| EEl            | 107                  |
| Flue gas data  | 273°C at 25°C, 12Pa. |

Combustion Chamber : (H x W x D):  
245-360/300/280mm

Flue outlet:  
Ø 15cm (Mounting height top: 99cm)

Distance to non inflammable:  
5-10cm (Recommended)

Distance to inflammable wall and materials:  
Rear = 30cm, Sides = 45cm, In front = 110cm

## Technical Specification Femø

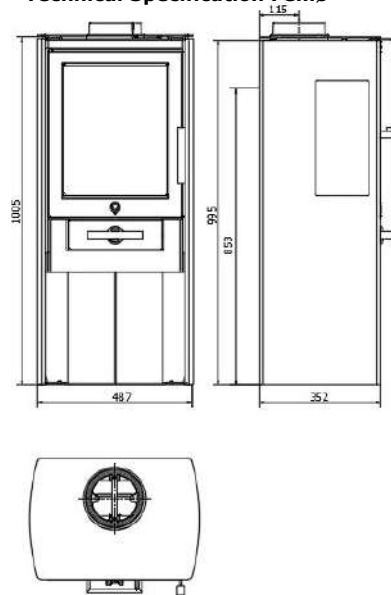

### Model Femø

|                |                      |
|----------------|----------------------|
| Height (mm)    | 1005                 |
| Wide (mm)      | 487                  |
| Depth (mm)     | 352                  |
| Weight (kg)    | 85                   |
| Effect         | 3-7 kW               |
| Nominal Output | 5,5 kW               |
| Heated area    | 30-105m <sup>2</sup> |
| Efficiency     | 80 %                 |
| EEl            | 107                  |
| Flue gas data  | 273°C at 25°C, 12Pa. |

Combustion Chamber : (H x W x D):  
245-360/300/280mm

Flue outlet:  
Ø 15cm (Mounting height top: 99cm)

Distance to non inflammable:  
5-10cm (Recommended)

Distance to inflammable wall and materials:  
Rear = 30cm, Sides = 45cm, In front=110cm

## Technical Specification Bøgø

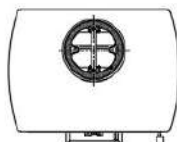
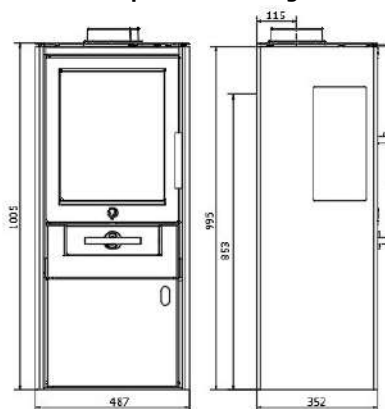

### Model Bøgø

|                |                      |
|----------------|----------------------|
| Height (mm)    | 1005                 |
| Wide (mm)      | 458                  |
| Depth (mm)     | 352                  |
| Weight (kg)    | 85                   |
| Effect         | 3-7 kW               |
| Nominal Output | 5,5 kW               |
| Heated area    | 30-105m <sup>2</sup> |
| Efficiency     | 80 %                 |
| EEl            | 107                  |
| Flue gas data  | 273°C at 25°C, 12Pa. |

Combustion Chamber : (H x W x D):  
245-360/300/280mm

Flue outlet:  
Ø 15cm (Mounting height top: 99cm)

Distance to non inflammable:  
5-10cm (Recommended)

Distance to inflammable wall and materials:  
Rear = 30cm, Sides = 45cm, In front = 110cm



### Important!

**Before** lighting up your **Varde Stove** for the first time, we recommend that you read these instructions carefully and contact your local stove vendor or building authorities to inquire about existing regulations regarding the intallation of stoves. Please follow these regulations closely.

#### Inspection of installation

It is very important that the installation is inspected by a qualified chimney sweeper before the stove is used the first time.

#### This **Varde Stove**

Has passed the Danish /European Standard DS/EN 13240 Norwegian (NS) and the German (Stufe 2) test , and have thereby proved to be a environmentally friendly product.

### Regulations

All local regulations as well as National and European, should be adhered to when installing your stove.

All Varde Ovne stoves are closed fireplaces.

The stove is designed for intermittent combustion and can be connected to a chimney used by other fireplaces, as long as the appropriate rules and regulations are adhered to.

### Professional installation

We recommend that you consult with the dealer where you purchased the stove or an other competent installer, as there may be specific things to consider during the installation. You should also reseive the applicable rules for installing the stove and follow them.

### Please Note!

You are by law required to register your stove at the local chimney-sweeper.

Until installation keep the stove dry and not to cold. The stove cannot stand moisture. That an existing chimney, not necessarily is effective enough for a new modern stove. Vermiculite is a very porous material, therefore handle with care. When refilling the stove, put the wood carefully, use the glove.

#### EC declaration of confirmaty.

##### MANUFACTURER

Name: **Varde Ovne A/S**  
Adress: Soldalen 12, DK-7100 Vejle, Denmark

##### Stove Inspection

Name: **RRF**  
Adress: Im Lopperfeld 34b, 46047 Oberhausen, Germany

##### Product

Product type: Varde  
Type code: Anholt, Bornholm, Fur, Langeland, Femø and Bogø  
Standard: Heating stove, suitable for intermittent combustion  
Construction products (89/106/EC/) standard used  
EN 13240  
Application: Residential Heating  
Fuel: Wood  
Special conditions: Non

##### CE-Markning

Issued: 2017  
Nominal Output: 5,5 kW  
Fuel type: Wood  
Fluegas temperature: 273 °C  
Efficiency: 80 %  
Co-release: 0,08 %



---

Jan Meldgaard  
**CEO**  
**Varde Ovne**

**Flooring:**

If the floor on which the stove is to be placed is inflammable, the floor must be covered with non-flammable material, such as steel or glass plate, floor tiles or artificial slate, covering an area of at least 15 cm from the sides of the stove and at least 30 cm from the front of it. Regarding the

| <b>Weight</b>  | Steel Stove |
|--|-------------|
| Varde Anholt, Bornholm, Fur, Langeland, Bøgø og Femø | 85 kg       |

**Installation distance:**

If walls are non-inflammable, the stove can be placed closer to them. However, we recommend a minimum distance of 5-10 cm, to allow for cleaning behind the stove. The cleanout gate must be accessible. Optimal combustion can only be obtained if fresh air is constantly admitted. It is important, therefore, to ensure that this is the case. The best way to provide a steady flow of fresh air is by installing 1-2 air vent's in the room where the stove is situated. (One in each side of the room).

According to existing regulations, stoves must be placed with the following minimum distances in mm to inflammable walls and materials. The distance from the outer edge of the flue pipe to inflammable material is described as for horizontal Flue 300mm and the distance for vertical flue is 225mm

## Installation distance

The stove must in accordance with applicable rules comply with the following minimum distances from inflammable walls and materials:

**Sides : 45cm**

**Rear : 30 cm**

**Distance to furniture : 110 cm**

Varde Femø, Bogø, Anholt, Bornholm, Langeland og Fur

|   |        |   |         |
|---|--------|---|---------|
| A | 300 mm | C | 450 mm  |
| B | 225mm  | D | 1100 mm |

### Anholt and Bornholm

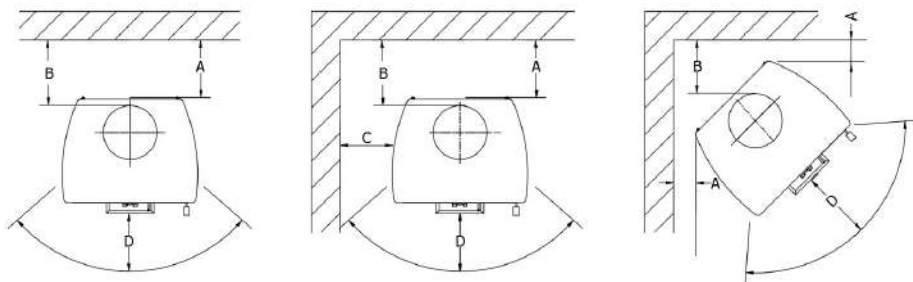

### Fur and Langeland

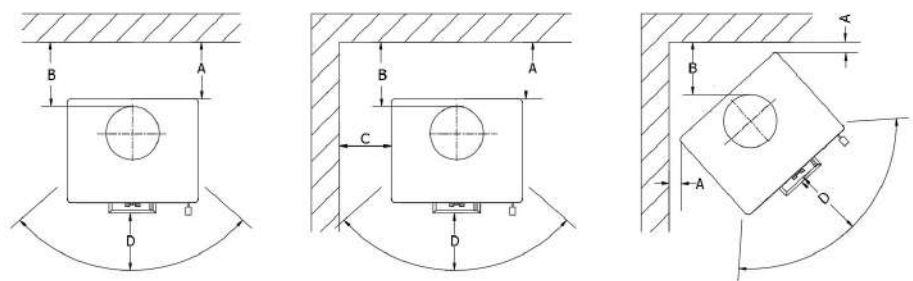

### Femø and Bogø

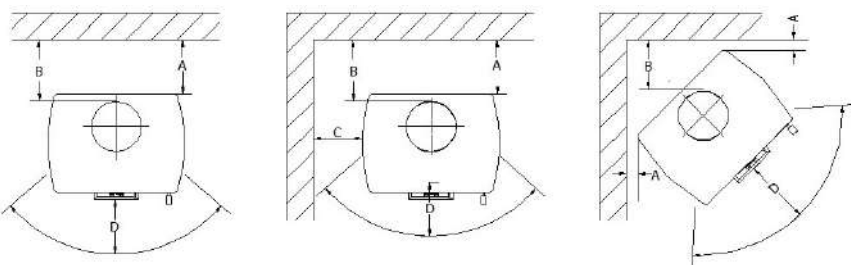

### The chimney:

Always use a chimney with a diameter of at least 15 cm. This corresponds to a clear of 175 cm<sup>2</sup>. Make sure the chimney is of a sufficient height, that it draws well and that smoke does not bother your neighbours.

We recommend that you fit your chimney with a damper, allowing for draft control. This may prove particularly important on windy days.

Note: the damper must never shut off draught completely – always allow at least 20 cm<sup>2</sup> free passage through the chimney.

With nominal usage the stove has tested a flue gas flow of 4,9g/second and with a flue gas temperature of 328°C in a room of 25 °C.

Varde stoves are always fitted with a smoke plate which redirects smoke to make its way to the chimney as effectively as possible. This ensures that the heat from the smoke is emitted inside your home rather than outside it. The smoke plate is moveable and placed on top of the Vermiculite fire brick side plate. You should make sure that it is pushed all the way back against the back wall of the combustion chamber.

### Draught conditions

Consult your local stove dealer about how best to adjust the draught in your chimney.

### Hight of chimney

If in doubt, contact your local stove dealer. He will be able to inform you of the correct hight.

### Connection of Flue pipe:

The Stove is mounted with Flue adaptor on the

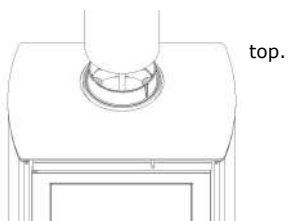

### Information about the new cast iron adapter.

Your stove is equipped with the new cast iron adapter from Varde Ovne. The adapter is suitable for smoke pipes with inner diameter on 150 mm.

If you need it, it's now possible for you to make a condensate drain-hole in the adapter.

- ◆ Carefully punch a chisel or the like through the adapter in the outer groove, at the arrow mark. This way you can establish a condensate drain hole in the adapter.

Arrow mark for the hole.

Carefully punch a hole with a chisel or the like.

Now the condensate – hole is ready.



**Continual fresh air**

A continual supply of fresh air is required in the room in which the stove is situated. This can be achieved by installing 1-2 vents, whilst also ensuring that these can not be blocked. The quantity of air used for burning, is approx. 14 m³ / h.

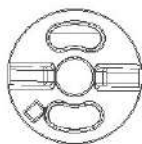

**Ignition air**  
On Ashpan - **Open**

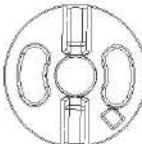

**Ignition air**  
On Ashpan - **Closed**  
This option is only for use at lightning up. As soon as the fire has a good grip in the wood—remember to close again.

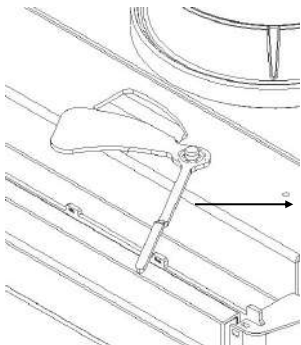

**Combustion air throttlet**  
Push the throttlet towards right for opening.

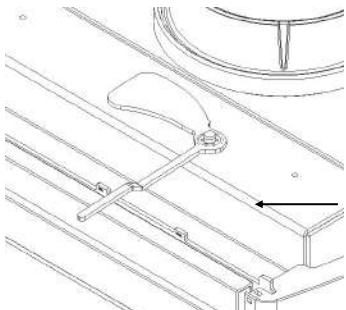

**Combustion air throttlet**  
Push the throttlet towards left for closing.

**Combustion /Secondary air**

Pre-heated air for the combustion process, the amount of which can be altered according to the desired room temperature and the effectiveness of the chimney. A high level of chimney draught requires a lesser intake of combustion air.

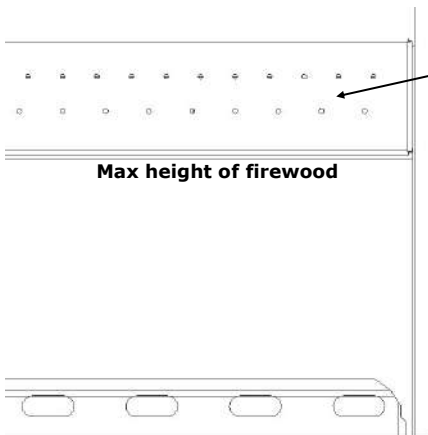

**Max height of firewood**

**Tertiary air**

Is constantly added air, which makes the stove burn even cleaner, and lowers the content of tar and soot in the combustion process to an absolute minimum. At optimal combustion settings, glass and combustion chamber will be burnt completely clean, and the remaining amount of ashes will be minimal.

**Overheating**

Occurs if too much wood is placed in the stove or if the combustion receives too much air.

## How it works

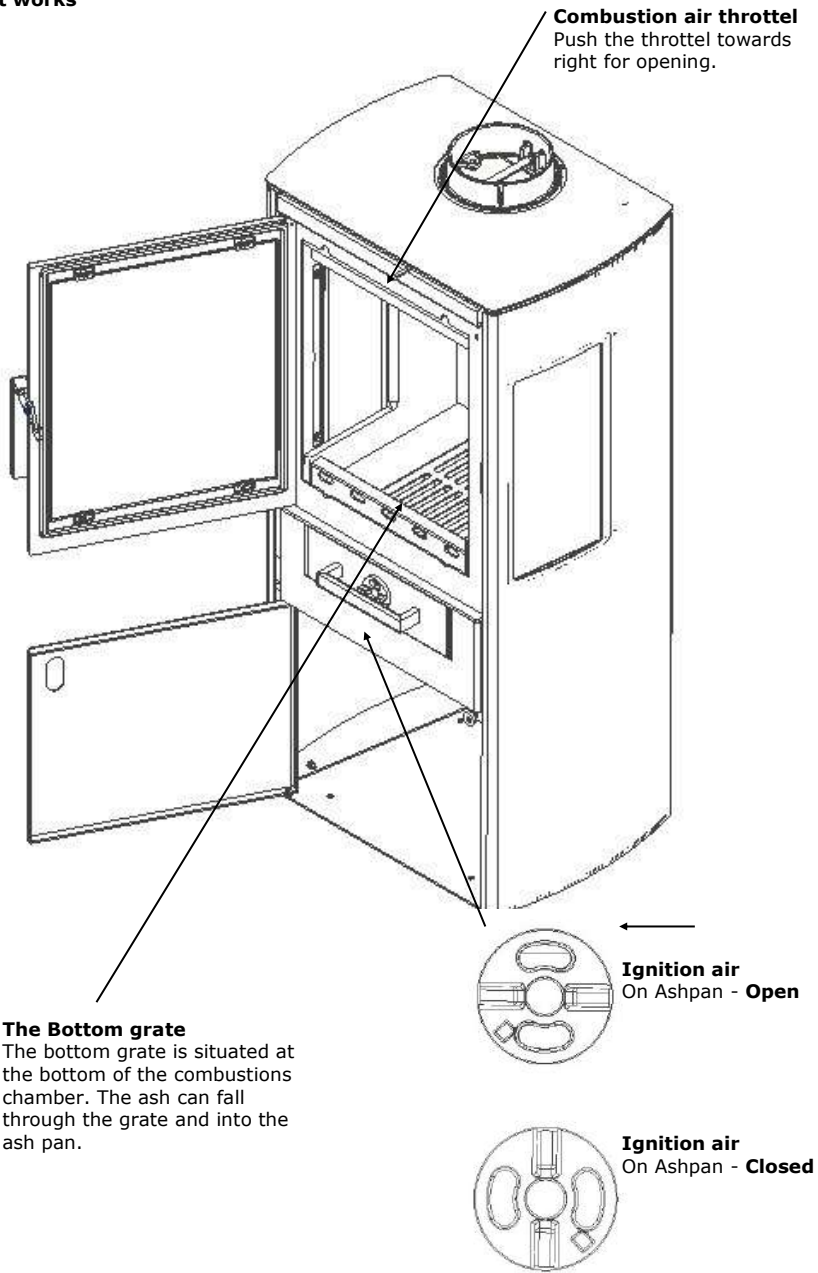

### **How to light and stoke a fire:**

The first time you light up the stove the enamel will temper, and give off some smoke and a slight smell. We recommend that you leave doors and windows open, as airing the room will make the smell disappear. This tempering softens the enamel making it susceptible to damage. Therefore exercise caution and avoid touching the enamel. Likewise we recommend opening the door to the stove at regular intervals for the first hours to prevent the insulations rope from sticking to the enamel.

**Never** use highly inflammable fluids such as methylated spirit and petrol for lighting up!

We recommend a "Top-Down" lightning, where you light the wood in the upper area of the combustions chamber and not in the ground. This method is the most environmental method to light a fire. The method will keep the glass clean. In the combustion chamber you make a cross (⚡) of 4 small pieces of wood with a small distance between each one of them (0,7-1,1kg). On top of them you make another cross (⚡) of 8-12 smaller sticks (0,4-0,7 kg.), on top of this firewood and in between use 2-3 kildning blocks. In total approximate 1,5kg of woods. A thin layer of ashes at the bottom of the stove makes lighting up a fire easier.

Before lighting up the stove, open ignition air on the ash-pan for access of **primary air**. The throttle for the Combustion Air is drawn towards the right and hereby fully opens for combustion air.

When the fire burns remember to close the the Ignition air again, or the stove and chimney might become overheated and will invalidate the warranty. Also make sure the ash pan is closed proper.

Hereafter the combustion air are adjusted to the need of heat. Be aware not to close too much for the air supply, otherwise the fire will die, the fire must always be bright and clear.

In most instances, however, you will have to achieve the **best combustion air settings** yourself, as the height and draught of your chimney, as well as the quality of the firewood are decisive factors in determining how your particular stove is best set.

If the stove nominal heat output is too large compared to the heat demand, you can reduce the output as described here:

- use a smaller amount of wood than usual, for example. 0,9 to 1.2 kg. and preferably consist of 3-4 smaller pieces of wood. Apply full air to ignite the wood properly, then you can reduce the combustion air, perhaps down to approx. 60%. Be aware not to close too much for the air supply, otherwise the fire will die, the fire must always be bright and clear.

With this method it, (depending on the chimney, wood quality, etc. is possible to reduce the stove heat output from a nominal 5,5 kW down to maybe 3 to 3.5 kW.

Please be aware that it can lead to poor combustion, if you regulate too much down the combustion air, resulting in a lower efficiency and increased emission levels in the smoke. (increasing pollution).

### **Tertiary air**

If you are wondering why your stove is fitted with a gap in the rear vermiculite plate in the combustion chamber, with small holes through the back steel plate, where air is running through into the combustion chamber. This is merely a consequence of our newly developed combustion system. We refer to these air ducts as the 'tertiary air', and will prove helpful as you install your new Varde stove.

When refilling the stove with wood, we recommend opening the stove door only once embers are left in the combustion chamber. Opening the door whilst the flames are still burning and producing smoke and gas, might cause smoke to slip into the room instead of up the chimney.

Should you have some issues with the lightning or the function, see section on **troubleshooting**.

## Operation

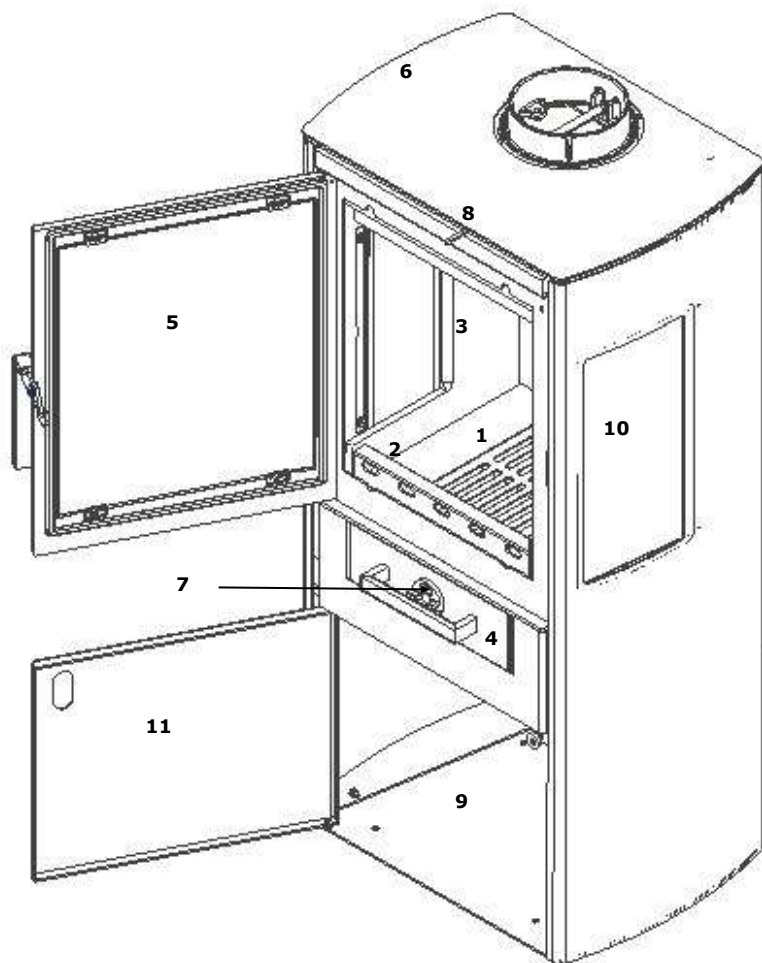

1. Bottom grate
2. Log retainer
3. Vermiculit plates
4. Ash pan
5. Cast iron door
6. Steel top
7. Throttlet for ignition air
8. Combustion air throttel
9. Storage
10. Site panels
11. Storage door (only on Bornholm, Bogø and Fur)



## Vermiculite

**The plates in the Combustion Chamber are Vermiculite plates** and will eventually be worn, - as will the smoke plate. Should you accidentally break the plate, for instance by hitting it hard with a piece of wood, this does not effect the quality of the combustion. You need not replace the plate until the gap is 5 mm wide.

### Vermiculite

A special non-flammable material. The vermiculite fire plates both isolate and protect the stove from attrition. Vermiculite plates and deflector not covered by the warranty. Vermiculite is a very porous material, therefore handle with care. When refilling the stove, put the wood carefully, use the glove.

**Only use original parts from Varde Ovne A/S**

**Vermiculit set,  
Item no.: 100882**

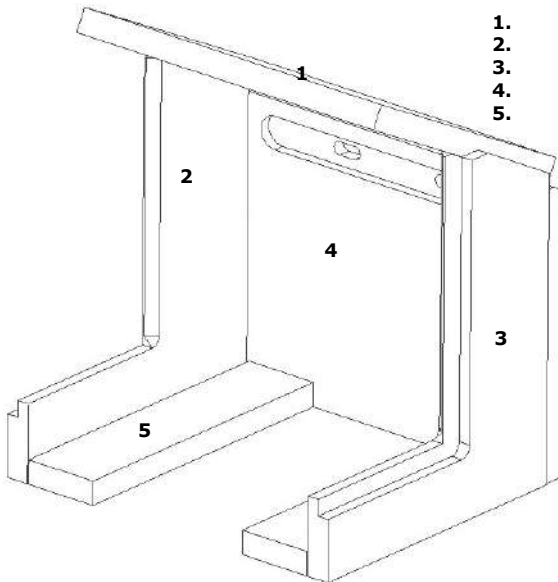

- 1. Deflector plate**
- 2. Left side plate**
- 3. Right side plate**
- 4. Rear cover**
- 5. Grate Plates**

### How too replace the Vermiculite

1. Remove Grate plates (5)
2. Deflector, lift easily, bottom bag end are tilted forward, take down.
3. The left side plate can be easily liftes up and rotated out.
4. Right side plate can be easily lifted up and rotated out.
5. The Rear cover is liftes up and out of the stove.

Mounting of new Vermiculite plates follow point 5 towards point 1.

### What kind of wood to use?

Generally, beech wood is considered the best type of wood for burning. It burns evenly without producing much smoke and ashes are clean and take up little space. Ash, birch and maple wood are fine alternatives.



### How big the firewood?

Split firewood with a diameter larger than 10 cm. Use firewood with a length on 20-25 cm. The use of larger quantities of fuel than recommended in the tabel below will overtax the stove and resulte in increased temperatures in the chimney as well as a lowered efficiency. This may cause damage to both chimney and stove, and the annulment of the warranty. Also, never use toxic materials such as chipboard, painted or impregnated wood.

### Lightnings sticks

Length: 20 -25 cm

Wide 3x3 cm

Normal amount: 10-15 sticks (approx. 1,5 kg)

### Firewood

Length: 25-30 cm

Diameter: max. 10 cm

Normal amount: 3-4 firwood (approx. 1,2kg)

### The new stove

The first time you light up the stove the enamel will temper, and give off some smoke and a slight smell. We recommend that you leave doors and windows open, as airing the room will make the smell disappear. This tempering softens the enamel making it susceptible to damage. Therefore exercise caution and avoid touching the enamel. Likewise we recommend opening the door to the stove at regular intervals for the first hours to prevent the insulati- ons rope from sticking to the enamel.

### What to burn.

This Varde Stove is tested and approved for the burning of wood. Only dry wood with a moisture content of maximum 21 percent and the size to fit into the combustion chamber should be used. The burning of moist wood will result in an increased amount of tarry soot, pollution and uneconomic fuel consumption. Newly chopped wood contains about 60-70 percent moisture, which makes it completely unsuitable as fuel. Allow newly chooped firewood to dry in a open shed for a couple of years before using it in the stove.

### Do not use! - Consider the environment

Also, never use toxic materials such as chipboard, painted or impregnated wood.

The use of larger quantities of fuel than recommended in the tabel below will overtax the stove and resulte in increased temperatures in the chimney as well as a lowered efficiency. This may cause damage to both chimney and stove, and the annulment of the warranty.

### Topdown Lightning of the fire



The following optimal register and fuel quantity settings are recommended (in case of similar chimney draught):

| Fuel Quantity [kg] | Primary Air open [%] | Combustion Air open [%] | Nominal Output [kW] | Chimney Draught [PA] | Efficiency [ $\geq i$ %] | Refill interval at nominal output [minuts] |
|--------------------|----------------------|-------------------------|---------------------|----------------------|--------------------------|--|
| 1,2                | 0 (closed)           | ca. 60                  | 5,5                 | 12                   | 80                       | ca. 45                                     |

## **Maintenance**

Like any piece of equipment in daily use, your stove needs maintenance.

The stove should only be cleaned when cold. Use a dry cloth for cleaning the exterior of the stove.

Clean the interior regularly by removing ashes, soot and tar from the combustion chamber. The smoke deflector plate should be removed for cleaning, as the reverse side will be covered in dirt and soot. Finally check that the smoke pathway through the flue pipe and chimney is completely clear. You should also inspect the rope seals in the door and ash pan for signs of wear. Replace them if they no longer seal properly. Also, remember to lubricate the door hinges as required.

## **Glass pane**

The glass pane should be cleaned using Varde Glas Cleaner, which is available at all DIY centres selling **Varde Ovne stoves**.

Empty the **Ash pan** regularly. It can be emptied into your dustbin, as long as you make sure it does not contain any hot embers. If in doubt about how to clean your stove, contact the dealer where you bought your stove, or your chimney sweeper.

It is especially important to check the stove and the chimney for blockages after a long period of non-use.

**The enamelled surface** of the stove may wear down in certain places if the stove is **overheated**. Worn surfaces can, however, be repaired with a special Senotherm<sup>®</sup> spray paint, available from your local dealer.

**The plates in the combustion chamber** are **vermiculite plates** and will eventually become worn, as will the smoke deflector plate. Accidental breakage of a plate, for instance by hitting it hard with a piece of wood, will not affect the quality of the combustion. You do not need to replace the plate until the gap is 5 mm wide.

## **Only use original parts from Varde Ovne A/S**

The door is equipped with a spring, which pulls the gate closed. This is a legal requirement in many countries. The spring is fitted to the hinged side of the door but can be removed if you prefer the door not to be spring-loaded.

**Do not make any unauthorised changes to the stove.**

**All external parts of the stove become hot during use, and you should therefore exercise due caution.**

## **IMPORTANT!!**

### **Chimney fires**

Should your chimney catch fire, cut off the air supply to the stove's combustion chamber and contact the emergency service. (The majority of fires die out after the oxygen supply is cut off.) You should subsequently contact your chimney sweeper, who will check your stove and chimney for damage

## **Troubleshooting.**

### **Smoke enters the room:**

- Not enough draught in the chimney.
- Inspect the smoke pipe or the chimney for blockage.
- Clean the inside of the stove removing soot from the upper vermiculite / smoke (Deflector) plate.
- Make sure the height of the chimney is correct.

### **The glass or the chimney soot up:**

- The wood is too moist.
- Not enough secondary air is applied to the combustion process.
- You may have shut off the supply of ignition air too early when lighting up the stove.
- There always have to be clear flames in the combustion chamber.

### **The heat is emitted from the stove:**

- The wood is too moist (all energy goes into drying it) or of a poor quality.
- Inspect the position of the smoke plate and make sure there is free passage for the smoke.
- The amount of combustion(secondary air) air is not enough.

### **Combustion is too intense:**

- Gaskets in the door or the ash-pan are no longer tight and need replacement.
- The chimney draught is too strong—apply a valve in the chimney.
- Inspect that the ignition air is closed.

### **The Shake grate is stuck:**

- Inspect the grate for jammed wood, nails or the like.
- Make sure the lever is placed correctly.

## **Recycling**

### **Packing**

The packing is 100% recyclable.



### **Ceramic Glass**

Ceramic glass to be deposited at the local recycling center and sorted together with pottery and porcelain.

### **Vermiculite**

Vermiculite plates from the stove must be returned to the local recycling center.

## **Spare Parts**

If Spare parts at any time should be needed, please check the list below.

**Log retainer, Artikel nr.: 100366**

**Top Cover steel Ø165 VO-Logo, Artikel nr.: 100701**

**Door Complete Cast Iron Artikel nr.: 100577**

**Glass, Artikel nr.: 100272**

**Glass Side Panel inside, Artikel nr.: 100883**

**Glass Side Panel exterior, Artikel nr.: 100884**

**Handle Complete, Artikel nr.: 100363**

**Ashpan Complete Black, Artikel nr.: 100364**

**Vermiculite Set, Artikel nr.: 100882**

**Sealing Rope 3 x 8 mm/2,0m, Artikel nr.: 100443**

**Sealing Rope Ø10/2,5 with glue 50 ml, Artikel nr.: 100351**

- ✦ Anerkendt prøvestiftelse, godkendt af Europakommissionen (EU) Nr. 305/2011, notified body: 1625
- ✦ Prøvestiftelse efter DIN EN ISO/IEC 17025:2005, DAkkS Nr. D-PL-17727-01-00
- ✦ Anerkendt prøvestiftelse i h. t. Delstatsbyggevedtægtene, reg.nr.: NRW 15
- ✦ Anerkendt prøvestiftelse for byggetillægmæssige tilladelser
- ✦ Anerkendt DIN CERTCO prøvestiftelse, reg.nr.: PL139

## PRØVNINGSATTEST

**Kontrolerklæring nr:** RRF - DK 17 4609

**Prøvens art:** Prøve i h. t. EN 13240:2001/A2:2004/AC:2007

**Ordregiver:** **Varde Ovne A/S**  
Soldalen 12, DK-7100 Vejle

**Genstand for prøven:** brændeovn  
**Boge**  
**Femø, Fur, Langeland, Bornholm, Anholt**

**Nominal varmeydelse:** 5,5 kW

### Emissioner i forbrændingsprodukterne relateret til 13 % O<sub>2</sub>.

|                 |                      |  |
|-----------------|----------------------|--|
| CO-emissionen   | 0,08 %               |  |
| Støvemissionen: | 9 mg/m <sup>3</sup>  | efter CEN/TS15883, Annex A. 1 (DINplus metode) |
| OGC             | 81 mg/m <sup>3</sup> | efter CEN/TS15883, Kapitel 4                   |

**Virkningsgrad:** 80 %

**CVR nr.:** 21554979

**P-nr.:** 1005018532

**Prøvningsresultater:** Det attesteres herved at ovenfor nævnte fyringsanlæg opfylder emissionskravene i; Bilag 1 til bekendtgørelse nr. 46 af 07/12/2015 vedr. regulering af luftforurening fra fyringsanlæg til fast brændsel under 1 MW (1. og 2. trin)

Bemærk venligst, at de oplyste værdier er uddrag af prøvningsrapporten.

Godkendelsesafdelingens leder

Skorstensfejer påtegning

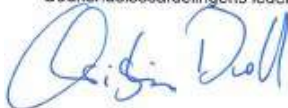

(C. Droll)

Oberhausen, 02.05.2017

Dato,

underskrift

## Warranty

All **Varde** stoves go through a close quality inspection, and we take pride in always delivering products of a consistent quality. This being so, manufacturing faults may still occur, and on these we offer a **5 year warranty**.

### The warranty does not include:

- wearing parts, such as the Vermiculite plates in the combustions chamber, the smoke plate, glass, gaskets, cast iron bottom and shacking grate.
- Damages whichs occur as a consequence of misuse, such as over-heating, incorrect installation, missing or wrong maintenance etc. (see instructions earlier)
- Damages caused by external influence of a physical character.
- Cost of transportation in connection with warranty repairs.
- Assembling/reassembling in connection with warranty repairs.
- Compensation for following damages, including damage on other objects.

### Warranty conditions:

These instructions for use are also your proff of warranty. The warranty will not take effect until vendor's stamp, information about model, registration numer and date of purchase (invoice if possible) have been applid below. In case of claims, please bring this proof of warranty to your local vendor.

Model: \_\_\_\_\_

Reg.no.: \_\_\_\_\_

Date of purchase: \_\_\_\_\_

Vendor's stamp and signature





**VARDE OVNE**

**Soldalen 12, 7100 Vejle, Danmark, Tel. +45 7482 0003. [vardeovne.dk](http://vardeovne.dk)**