



Kamina

RADIANT FLAME EFFECT GAS FIRE

Installation and Maintenance Instructions

Hand these instructions to the user

Model No's FCRR10RN is for use on Natural Gas (G20) at a supply pressure of 20 mbar in G.B. / I.E.

CONTENTS

Section 1	Information and Requirements	PAGE
1.0	Appliance Information	3
1.1	Conditions of Installation	4
1.2	Flue and chimney suitability	4
1.3	Fireplace / surround suitability	5
1.4	Shelf position	5
1.5	Chimney inspection	5
1.6	Chimney opening / catchment space	6-7
1.7	Precast flues	8
1.8	Metal flue boxes	8
1.9	Hearths	8
1.10	Spillage monitoring system	9
Section 2	Installation of Fire	
2.1	Unpacking the fire	10
2.2	Installing the combustion chamber & closure plate	10
2.3	Preparation of the flue opening	11-13
2.4	Fitting the batteries to the receiver unit	14
2.5	Gas tightness and inlet pressure	15
2.6	Removal of the controls cover	15
Section 3	Assembling Fuel Bed and Commissioning	
3.1	Lighting the appliance	16-17
3.2	Checking for clearance of combustion products	18
3.3	Fixing the “Kamina” fascia in position	19
3.4	Removal & re-fitting of the glass frame assembly	20
Section 4	Maintenance	
4.1	Removal of the burner assembly	21
4.2	Removal of the valve / solenoid	21-22
4.3	Removal of the pilot assy.	22
4.4	Removal of the RF receiver / battery pack	22
	Parts Shortlist	23

This appliance is manufactured by :-

BFM Europe Ltd, Trentham Lakes, Stoke-on-Trent, ST4 4TJ

SECTION 1 INFORMATION AND REQUIREMENTS

1.0 APPLIANCE INFORMATION

Model	FCRR10RN
Gas Type	G20
Main injector (1 off)	Size 380
Pilot Type	Copreci 21100 / 141
Max. Gross Heat Input :	6.5 kW
Min. Gross Heat Input :	3.5 kW
Cold Pressure :	20.0 +/-1.0 mbar
Ignition :	1.5V Battery Generator
Electrode Spark Gap :	4.5mm Nominal
Weight :	33 kg

Fire box Dimensions (with & without fascia's fitted)

Width : (with fascia fitted)	890mm
Height : (with fascia fitted)	650mm
Projection from wall : (overall-without fascia fitted)	130mm
Projection from wall : (overall-with fascia fitted)	146mm

Gas Connection : 8mm Compression (Supplied with fire)

Efficiency Declaration

The efficiency of this appliance has been measured as specified in BS 7977-1 : 2002 and the result is 64%.

The gross calorific value of the fuel has been used for this efficiency calculation.

The test data from which it has been calculated has been certified by Advantica. The efficiency value may be used in the UK Government's Standard Assessment Procedure (SAP) for energy rating of dwellings.

1.3 FIREPLACE / SURROUND SUITABILITY

This fire can be installed with a fire surround in a conventional type installation (see page 11 for dimensional information) or without a fire surround, for a hang on the wall type installation. It must not **be installed directly onto carpet or other combustible floor materials.**

The fire surround if installed must be manufactured from non-combustible material and have a temperature rating of at least 150^oc.

If a heating appliance is fitted directly against a wall without the use of a fire surround or fire place all combustible material must be removed from behind the Imagination fascia. Soft wall coverings such as blown vinyl, wall paper etc. will be affected by the rising hot air and scorching and / or discoloration will result. Due consideration should be made to this when installing or decorating.

1.4 SHELF POSITION

The fire may be fitted below a combustible shelf providing there is a minimum distance of 200mm above the top of the fire and the shelf does not project more than 150mm. If the shelf overhangs more than 150mm the distance between the fire and the shelf must be increased by 15mm for every 25mm of additional overhang over 150mm.

1.5 FLUE / CHIMNEY INSPECTION

Before commencing installation, a flue or chimney should be inspected to ensure that all the following conditions are satisfied.

1. Check that the chimney / flue only serves one fire place and is clear of any obstruction. Any dampers or register plates must be removed or locked in the open position.
2. Brick/stone built chimneys or any chimney or flue which has been used for an appliance burning fuel other than gas must be thoroughly swept. The base of the chimney / flue must also be thoroughly cleared of debris etc.
3. Any under-floor air supply to the fire place must be completely sealed off.
4. Ensure that the inside of the chimney / flue is in good condition along it's length and check that there is no leakage of smoke through the structure of the chimney during and after the smoke pellet test. **With pre-cast flues it is especially important to check the inside of the flue for extruded cement / sealant protruding from the joints between the flue blocks. If present, these should be removed by rodding the flue before proceeding with the installation.**
5. **Using a smoke pellet, check that there is an up-draught in the chimney / flue and that the smoke can be seen issuing from the terminal / chimney pot outside.**

There must be no leakage of smoke through the structure of the chimney during or after the smoke pellet test and it is important to check inside upstairs rooms adjacent to the chimney / flue. Check the chimney pot / terminal and general condition of the brickwork or masonry. If the chimney or flue is in poor condition or if there is no up-draught do not proceed with the installation. If there is a history of down-draught conditions with the chimney / flue, a tested and certificated flue terminal or cowl suitable for the relevant flue type should be considered.

6. **A spillage test must always be carried out during commissioning of the appliance.**

1.6 CHIMNEY OPENING AND CATCHMENT SPACE

The front opening of the chimney must be between 300mm and 440mm wide, and between 300mm and 440mm high. If the opening exceeds these dimensions then an opening must be constructed from suitable non-combustible material to produce a correct size opening. Any opening must be suitably sealed to prevent leakage. See below in fig.1

Fig. 1

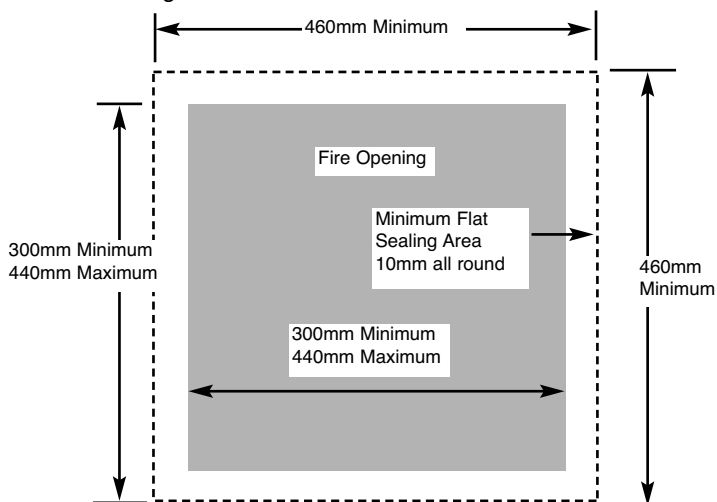

When installing into a brick built chimney, you must ensure that there is sufficient depth to accommodate any debris which may fall from the chimney. This depth must be sufficient to accommodate 12 litres of volumetric space.

Table A - Installation Depth Requirements for a Flavel Kamina being installed into a brick built chimney, requiring 12.0 litres of debris collection volume (fig. 2).

When installing this product into a builders opening / brick-built chimney, the depth required is a minimum of 156mm. The 12.0 litres of debris collection volume is achieved by the space available below the flue spigot.

This appliance is suitable for use in fireplaces fitted with an existing chairbrick without the need for removal of the chairbrick, providing the minimum depth of the fireplace exceeds 206mm. If the depth is less than 206mm then the chairbrick must be removed. The fireplace must be checked to ensure that no part of the chairbrick is within 50mm of the flue outlet of the fire when installed.

For example, if the appliance was to be fitted into a 300mm wide opening, the depth required would be 156mm. See fig. 2 below for explanatory diagram.

Fig. 2

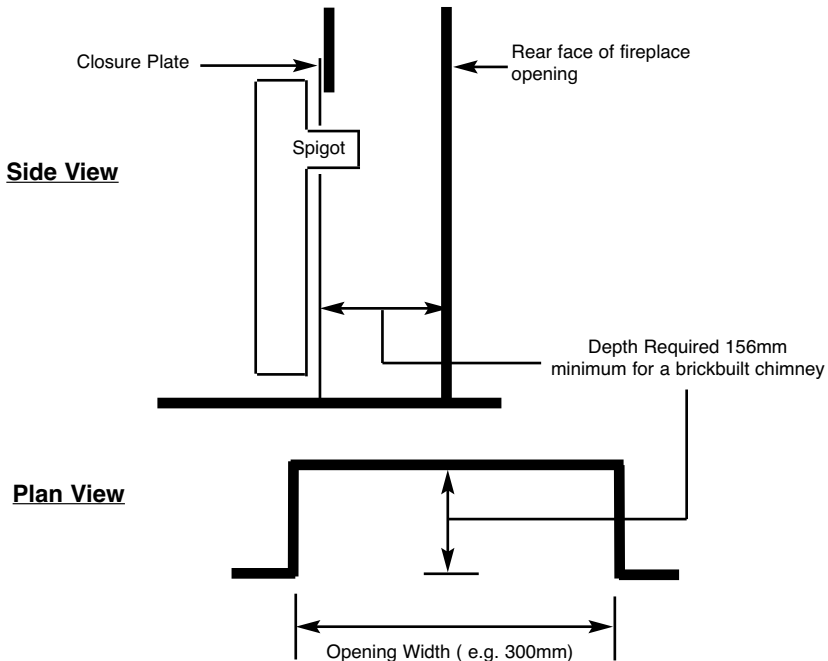

1.7 FITTING TO PRE-CAST FLUE INSTALLATIONS

To install the fire box in to pre-cast flue starter blocks, there must be at least 100mm from the mounting face of the fire to the rear of the pre-cast flue starter block to allow sufficient space for debris collection. It is important to consider this depth when choosing a fire surround as the thickness of the fire surround must be sufficient to give a total depth of **at least 100 mm to the rear of the starter block**, otherwise there will be insufficient depth. It is important to ensure that the pre-cast flue is in good condition and is free from extruded mortar or sealant from between the flue blocks.

This appliance has been tested for use in a pre-cast flue block complying with BS EN 1858. In accordance with BS EN 1858, pre-cast flues built with directly plastered faces (front or rear) are not correctly installed as to ensure proper operation with any type of gas fire. In some instances of this flue construction, temperature cracking of surface plaster may occur through no fault of the appliance. An air gap or some form of insulation material should be installed to prevent normal flue temperatures from damaging wall surfaces. IF FITTING TO A PRE-CAST FLUE SYSTEM, ALWAYS REMOVE THE FLUE RESTRICTOR PLATE.

1.8 FITTING TO PRE-FABRICATED TWIN WALL METAL FLUE BOXES

The appliance may be fitted to twin wall metal flue boxes conforming to the constructional requirements of BS 715, (for example the Selkirk LFE 125 box). The box must have a minimum flue diameter of 125mm internal and minimum internal dimensions of 100mm deep by 300mm high by 300mm wide. There are no maximum dimensional requirements for the box. The top face of the box must be insulated with a minimum thickness of 50mm of non-combustible mineral wool insulation or similar material. The flue box must stand on a non-combustible base of minimum thickness 12mm.

1.9 HEARTHES (IF SPECIFIED)

If fitting without a hearth panel, this appliance must only be installed at a minimum height to the base of the opening of 160mm above the floor level, (measured from the bottom edge of the "Kamina" fascia) e.g. above the level of the carpet or floor covering.

If fitted using a conventional hearth panel, the distance from the top face of the hearth panel to the bottom of opening / closure plate should be a minimum of 100mm

1.10 SPILLAGE MONITORING SYSTEM

This appliance is fitted with an atmosphere sensing spillage monitoring system in the form of an oxygen sensing pilot. This is designed to shut the fire off in the event of a partial or complete blockage of the flue causing a build up of combustion products in the room in which the fire is operated. **The following are important warnings relating to this spillage monitoring system :-**

- 1) The spillage monitoring system must not be adjusted by the installer.
- 2) The spillage monitoring system must not be put out of operation.
- 3) When the spillage monitoring system is exchanged only a complete original manufacturers part may be fitted. It is not possible to replace individual parts on the pilot system on this appliance, only a complete pilot assembly (including the thermocouple) may be fitted.

SECTION 2 INSTALLATION OF FIRE

2.1 UNPACKING THE FIRE

Carefully lift the fire out of the carton. Remove the loose item packaging carefully from the front of the appliance. Check the contents as listed :-

Packing Check List

1 off	Combustion chamber and glass frame assembly
1 off	Loose items bag including :-
	1 off Remote control handset
	1 off 6mm Allen key
	1 off each User instruction book and Installation book
	4 off 1.5V Batteries
	1 off Spigot & fitting screws
	1 off valve cover
	2 off M5 screws (to fit fascia to base brackets)
1 off	Kamina Fascia
1 off	Closure Plate

2.2 INSTALLING THE COMBUSTION CHAMBER & CLOSURE PLATE

Establish which type of flue you are intending to install the fire in to :-

225 x 225mm (9 inch x 9 inch) brick built chimneys

175mm (7 inch) diameter lined brick or stone flue, or insulated pre-fabricated metal flue box to B.S. 715.

When installing into 125mm (5 inch) diameter lined brick or stone flue, or insulated pre-fabricated metal flue box to B.S. 715 and pre-cast flues the restrictor baffle must not be fitted.

A spillage test must always be carried out to check satisfactory clearance of flue products, regardless of the type of flue the appliance is being fitted to.

PLEASE NOTE :- IF INSTALLING THIS PRODUCT INTO A HOLE IN THE WALL TYPE INSTALLATION IN WHICH THE FLUE TYPE IS PRE-CAST, SPECIALIST ADVICE MUST BE OBTAINED FROM A STRUCTURAL ENGINEER REGARDING THE RE-POSITIONING OF THE STARTER BLOCKS.

UNDER NO CIRCUMSTANCES SHOULD THE FIRE BE RECESSED INTO THE GATHER BLOCK, OFFSET OR STRAIGHT FLUE BLOCKS.

2.3 PREPARATION OF THE FLUE OPENING

If installing the product into a wall mounted installation, create an opening as shown in Fig. 3 below. If installing into a conventional opening with a hearth panel, create an opening as shown in Fig. 4 below.

Fig. 3 - Wall Mounted Installations

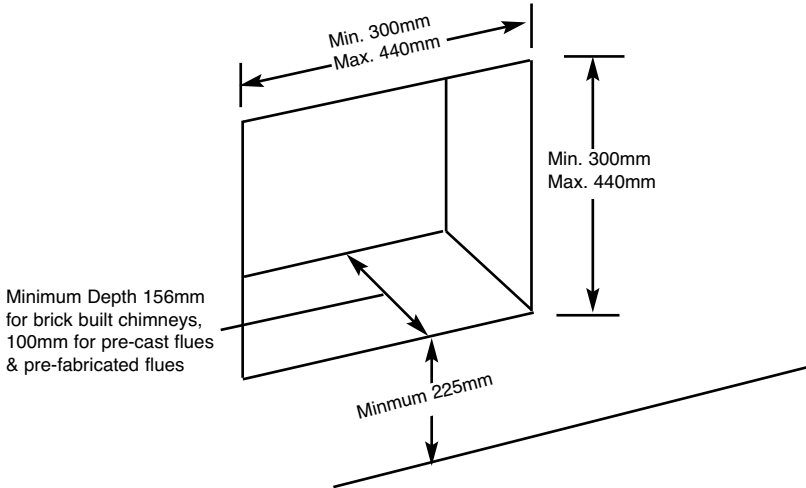
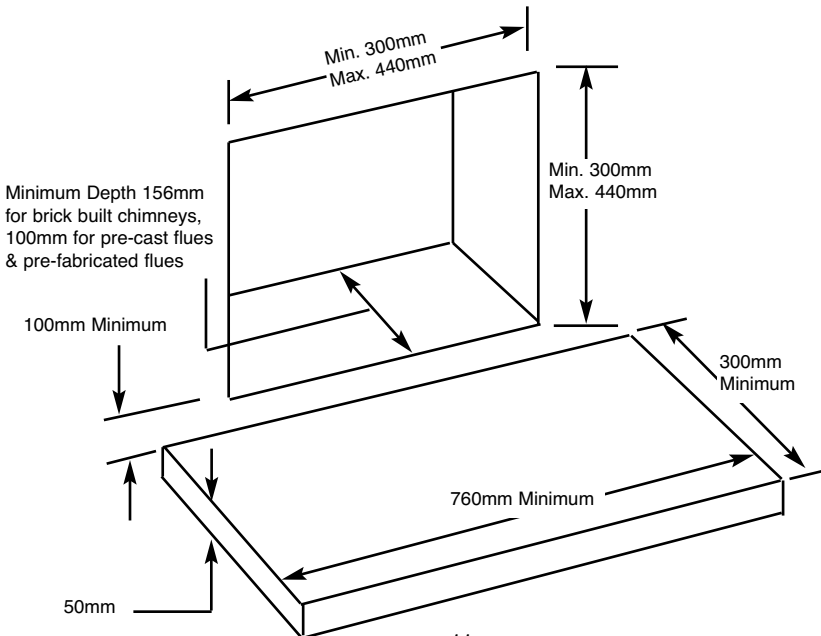

Fig. 4 - Conventional Installations



Proceed as follows :-

- a) Prepare the mounting holes on the wall to which the fire is to be fitted. See Fig. 5 below.

Fig. 5

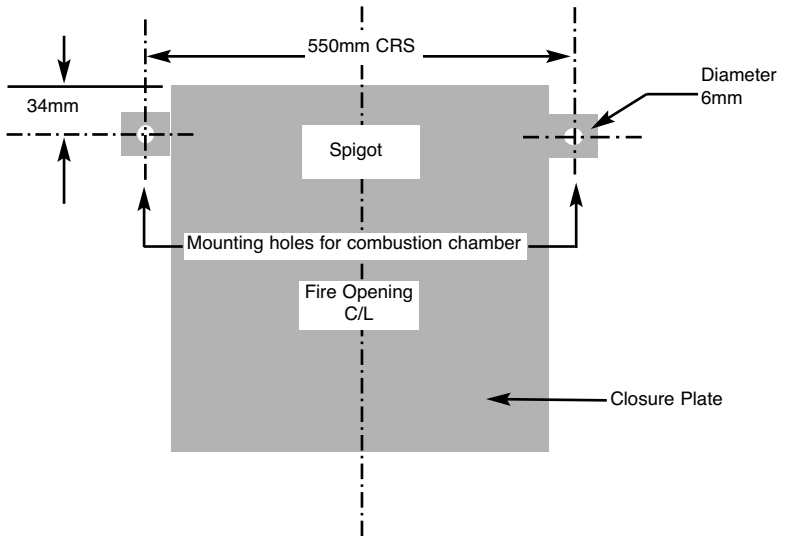

- b) Centre the closure plate around the fireplace opening and mark the positions of the mounting holes as shown above in fig. 5
- c) Remove the closure plate and drill suitable holes to suit the method of fixing to the wall.
Please Note : Due to the varying wall conditions encountered, fixings are not supplied with the product.
- d) Decide which side the gas supply is to enter the fire from. If concealed pipe work is required plan the pipe run to enter from behind the closure plate. This will require a cut out in the closure plate itself, or a suitable hole creating in the plasterboard / brickwork below the edge of the fire. See Fig. 6 overpage for diagram to relate the position of the gas inlet / restrictor elbow to the closure plate supplied. The gas connection to the appliance should be made to the isolating / inlet elbow using 8mm rigid tubing.
- e) Re-position closure plate and seal to the wall with suitable tape.
- f) The combustion chamber can then be mounted to the wall via the holes as detailed in section c).

Fig. 6

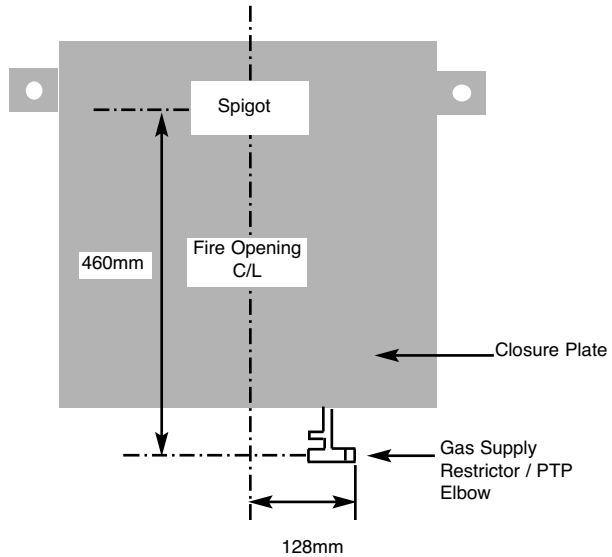

Note : Before breaking into the gas supply a tightness test should be carried out to establish that the existing pipework is sound.

- g) Before making the final gas connection, thoroughly purge the gas supply pipework to remove all foreign matter, otherwise serious damage may be caused to the gas control valve on the fire.

2.4 FITTING THE BATTERIES TO THE RECEIVER UNIT

- a) 4 off AA 1.5V batteries (found in the loose items pack) are to be fitted to the battery holder located centrally on the fire, below the combustion chamber as shown below in Fig. 7.

Fig. 7

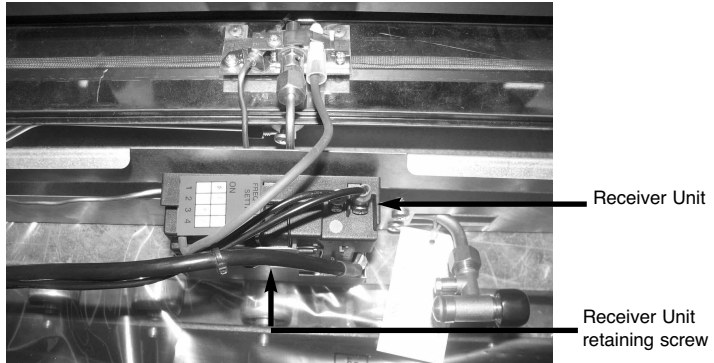

- b) To remove the receiver unit, firstly loosen the retaining screw that holds the unit in place.
- c) Slide off the cover from the receiver unit.
- d) Fit the 4 off AA batteries to the unit as shown in Fig. 8 and refit the cover.

Fig. 8

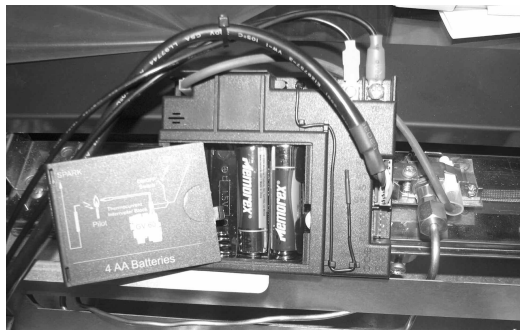

- e) Re-fit the receiver unit into its holder and tighten the retaining screw (do not over-tighten as this may damage the unit). Take care not to trap or damage any wires to the unit.

2.5 GAS TIGHTNESS AND INLET PRESSURE

- a) Remove the pressure test point screw from the inlet elbow and fit a manometer.
- b) Turn on the main gas supply and carry out a gas tightness test.
- c) Depress both the round buttons on the handset. The fire will then commence its ignition sequence and will light to high. See page 15 / 16 for full details of the operating method for the fire.
- d) Check that the gas pressure is **20.0 mbar (+/- 1.0mbar) 8.0 in w.g.(+/- 0.4 in w.g.)**
- e) Turn off the fire, remove the manometer and refit the pressure test point screw. Check the pressure test point screw for gas tightness with the appliance turned on using a suitable leak detection fluid or detector.

2.6 REMOVAL OF THE CONTROLS COVER

- a) The controls cover is located on the left hand side of the product (when viewed from the front). The cover is removed by gently lifting away in a vertical direction as shown below in Fig. 9, to reveal the control valve as shown in Fig. 10

Fig. 9

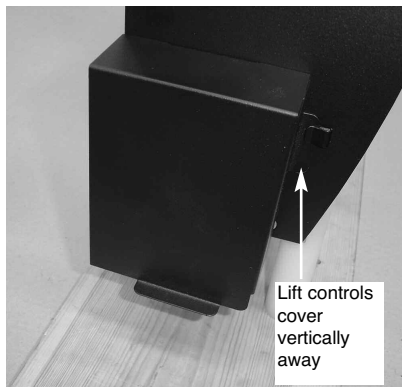
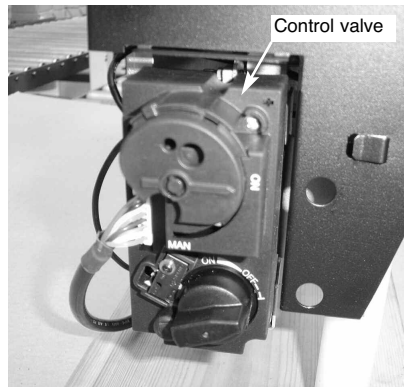

Fig. 10



- b) To re-fit the controls cover, locate in the slot and clip and fit back in position.

SECTION 3 COMMISSIONING OF THE FIRE

3.1 LIGHTING THE APPLIANCE

- a) The control valve is positioned on the left hand side of the fire when viewed from the front.
- b) To operate the appliance automatically via the remote control handset, ensure that the on / off switch is switched to the “on” position as shown below in Fig. 11

Fig. 11

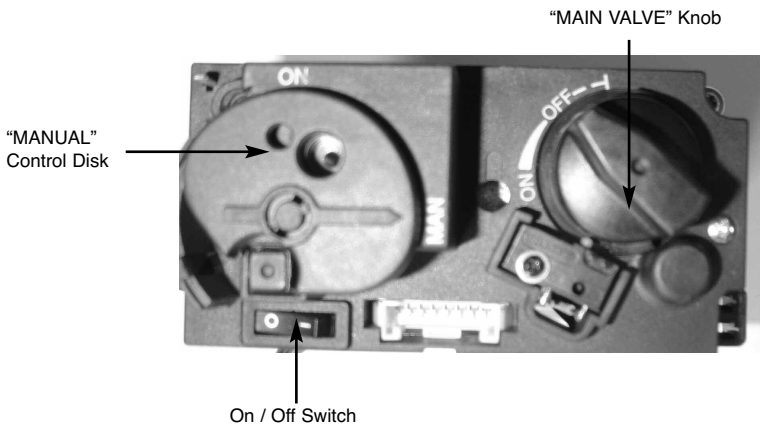

- c) Switch the MANUAL control disc to the “on” position. (Image above shows “MANUAL” control disc set in the “MAN” position).
- d) Switch the main valve knob to the “OFF” position. (Image above shows “MAIN VALVE” knob set in the “OFF” position).
- e) Press and hold the “STAR” button and “UP” button on the remote handset simultaneously, see Fig. 12 overpage for image of handset.
- f) The valve will then emit an audible beep and commence its ignition sequence. When the pilot flame has been established, the control will continue to beep whilst the thermocouple heats up. When the thermocouple has reached operating temperature, it will allow gas to flow to the burner and the burner will light at high rate heat input (6.5kW).

Fig. 12

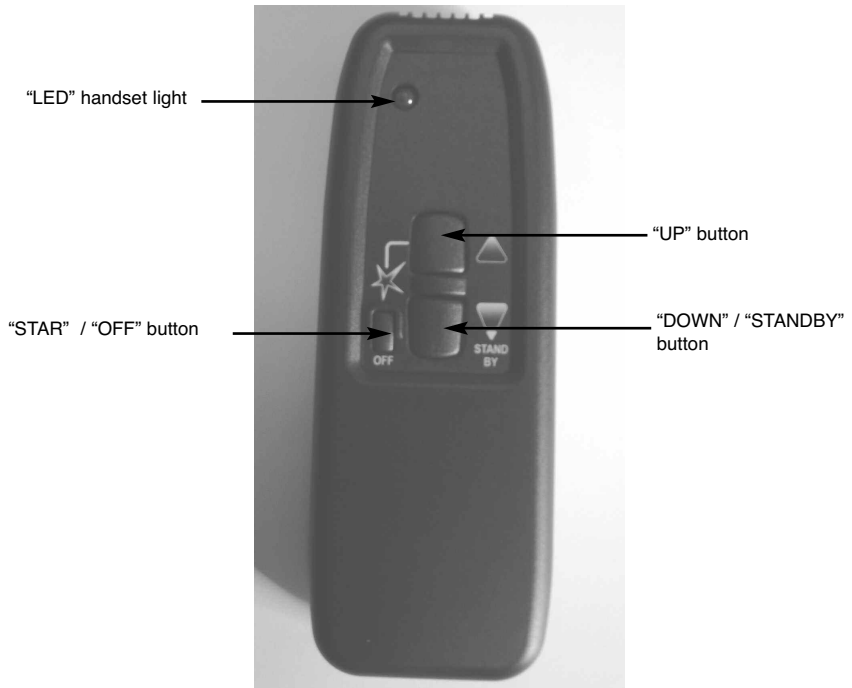

- g) The fire can now be switched between HIGH rate heat input and LOW rate heat input by pressing the "DOWN" arrow on the handset. To reduce the flame height of the main burner incrementally, press the arrow momentarily. To reduce the heat input directly down to the minimum level, press the "SMALL" flame arrow on the handset twice, NOTE : The flame will go to HIGH rate heat input before going to designated LOW rate heat input. To return back to HIGH rate heat input press the "LARGE" flame button twice. To put the fire in In "STANDBY MODE" (only the pilot remains lit) press and hold the "SMALL" flame arrow on the handset.

AFTER THE PILOT FLAME HAS BEEN EXTINGUISHED, IF YOU WISH TO RE-LIGHT THE APPLIANCE YOU MUST WAIT AT LEAST THREE MINUTES BEFORE TRYING TO RE-LIGHT THE FIRE.

- h) Should the handset be misplaced, you can turn the fire off by switching the "ON / OFF" switch to the "OFF" position.

3.2 CHECKING FOR CLEARANCE OF COMBUSTION PRODUCTS

- a) Close all doors and windows in the room.
- b) Light the fire and allow to run for approximately 5 minutes on high position.
- c) After approximately 5 minutes hold a smoke match as shown at the lower front edge of the draught diverter, as shown below in Fig. 13. It is recommended that a suitable smoke match holder is used when checking for clearance of combustion products. All smoke generated should be drawn back into the flue. If slight spillage occurs or if in doubt, repeat the test after a further 5-10 minutes.
- d) If spillage persists, remove the flue restrictor baffle from the spigot by removing the spigot itself, the two top screws secure the restrictor baffle and spigot to the rear of the combustion chamber. If after removing the flue restrictor baffle spillage still persists, the flue is not functioning correctly and a fault exists. If, after investigation the fault cannot be traced and rectified, the fire must be disconnected from the gas supply and expert advice obtained.
- e) If there is an extractor fan fitted anywhere in the vicinity of the appliance, the spillage test should be repeated with the fan running on maximum and all interconnecting doors open.
- f) After ensuring that the fire is safe to use it should be left on high position to fully warm up. During this time a slight odour may be noticed, this is due to the "newness" of the fire and will soon disappear. Finally, hand the Installation and Maintenance Instructions and the Users Instructions over to the customer and explain the operation of the fire.

Fig. 13



3.3 FITTING THE “KAMINA” FASCIA

- a) The “Kamina” fascia is fitted to the product by hooking the top edge of the fascia over the mounting brackets as shown in Fig. 14 below, then securing with two screws on the bottom face of the trim as shown in Fig. 15 below.

Fig. 14

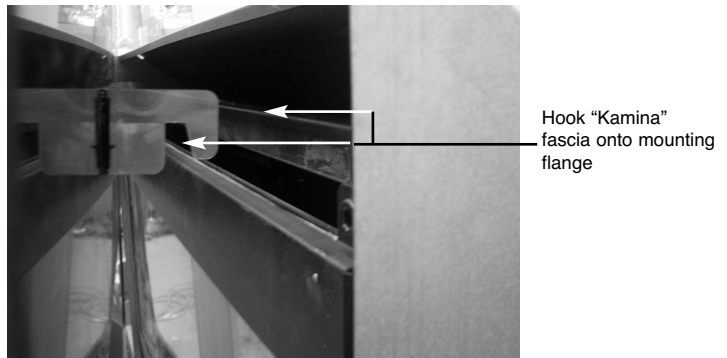
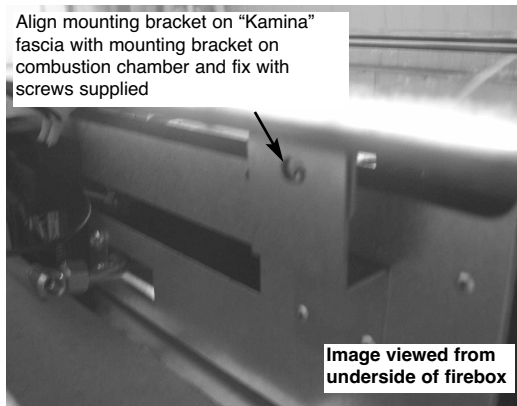

Fig. 15



3.4 REMOVAL & RE-FITTING OF THE GLASS FRAME & PANEL

- a) Remove the "Kamina" fascia by unscrewing the retaining screws and lifting the "Kamina" fascia off the brackets, in the reverse order as detailed in section 3.3, on page 19
- b) The glass frame is then removed by using the 6mm allen key supplied to unscrew the 4 off allen bolts (Fig. 16) and lifting the glass frame / panel clear.

Fig. 16



- c) To re-fit the glass panel / frame, re-assemble in reverse order.
- d) Replace the allen key supplied in its location slot at the bottom right hand side of the combustion chamber.

The ceramic fibre back used in this product is manufactured from R.C.F (Refractory Ceramic Fibre) To ensure that the release of fibres from this item is kept to a minimum, during installation and servicing we recommend that you use a HEPA filtered vacuum to remove any dust accumulated in and around the appliance before and after working on the appliance. When replacing these articles we recommend that the replaced items are not broken up, but are sealed within heavy duty polythene bags, clearly labelled as "RCF waste". RCF waste is classed as a "stable", non reactive hazardous waste and may be disposed of at a landfill licensed to accept such waste Protective clothing is not required when handling these articles, but we recommend you follow the normal hygiene rules of not smoking, eating or drinking in the work area, and always wash your hands before eating or drinking.

SECTION 4 MAINTENANCE

Servicing Notes

Servicing should be carried out annually by a competent person such as a GAS SAFE registered engineer. The service should include visually checking the chimney and fire opening for accumulations of debris and a smoke test to check for a positive up-draught in the chimney. The ODS pilot must be changed as a condition of the guarantee.

The condition of the fibreback should be checked and **if necessary it should be replaced with a genuine item.**

The burner assembly is designed to be removed as a complete unit for ease of access. **After any servicing work a gas tightness check must always be carried out.**

For Diagrams refer to Section 2

4.1 Removing the burner assembly from the fire.

4.1.1 Prepare work area (lay down dust sheets etc.)

4.1.2 Remove the “Kamina” fascia from the product as shown in section 3.3 on page 19 and put it in a safe location.

4.1.3 Remove the glass frame assembly as shown in section 3.4 on page 20 and put it in a safe location.

4.1.4 Isolate the gas supply and remove the inlet pipe from the appliance inlet elbow. Disconnect the pilot pipe, ignition wire and remove the pilot retaining screws. Unscrew and remove the two screws which retain the burner brackets to the base of the fire. Remove the burner from its location, on the injector

4.1.5 To refit the burner assembly, replace in reverse order and re-fit the glass frame assembly as shown in section 3.4 on page 20 and the “Kamina” fascia as described in section 3.3 on page 19.

4.2 Removing the Valve

4.2.1 Prepare work area (lay down dust sheets etc.)

4.2.2 Remove the “Kamina” fascia from the product as shown in section 3.3 on page 19 and put it in a safe location.

4.2.4 Remove the thermocouple retaining nut from the valve, remove the main pipe, inlet pipe and pilot pipe from the valve.

- 4.2.5 Remove the valve retaining screws and remove the valve. Re-assemble in reverse order and carry out a gas tightness test. Re-fit the “Kamina” fascia as described in section 3.3 on page 19.

4.3 Removing the Pilot Assembly.

Note : Because this appliance is fitted with an atmosphere sensing ‘Oxy-Pilot’ it is not possible to replace the thermocouple separately, because the thermocouple position is factory set to a tight tolerance. Any replacement of parts on the pilot requires a complete new pilot assembly.

- 4.3.1 Prepare work area (lay down dust sheets etc.)
- 4.3.2 Remove the “Kamina” fascia from the product as shown in section 3.3 on page 19 and put it in a safe location.
- 4.3.3 Remove the glass frame assembly as shown in section 3.4 on page 20 and put it in a safe location.
- 4.3.4 Loosen the pilot nut and remove the two screws retaining the pilot assembly. Unscrew the thermocouple from the gas valve.
- 4.3.4 Re-assemble in reverse order and carry out a gas tightness test and re-fit the glass frame assembly as shown in section 3.4 on page 20 and the “Kamina” fascia as described in section 3.3 on page 19.

4.4 Replacing the Batteries (Within the Radio Frequency Receiver)

- 4.4.1 Prepare work area (lay down dust sheets etc.)
- 4.4.2 Remove the “Kamina” fascia from the product as shown in section 3.3 on page 19 and put it in a safe location.
- 4.4.3 The RF receiver is located in the centre of the product, below the burner assembly. Unscrew the retaining screw and remove the RF receiver. Slide the battery cover off and replace the batteries as necessary.
- 4.4.4 Replace the “Kamina” fascia as described in section 3.3 on page 19.
- 4.4.5 Replace in reverse order and check correct operation of the appliance.
- NB The handset uses one LR61 (9v) and should be replaced by removing the cover on the rear of the handset.

ENSURE THE BATTERIES ARE CONNECTED TO THE CORRECT POLARITY POSITIVE (+), NEGATIVE (-)

PARTS SHORTLIST

Replacement of any other parts must be carried out by a competent person such as a GAS SAFE registered gas installer. The part numbers of the replaceable parts are as follows, these are available from BFM Europe, contact details as shown below.

This appliance must only be used with the fascia supplied.

Gas Control Valve	B-92200
Handset	B-159250
Receiver	B-153140
Ignition Lead	B-50380
Thermocouple Interrupter	B-93310
On / Off Switch & Supply Wires	B-93320
Ribbed Fibre Back	B-92030
Glass Panel	B-92020

Due to our policy of continual improvement and development the exact accuracy of illustrations and descriptions contained in this book cannot be guaranteed

**Part No. B-148240
Issue 2**



BFM Europe Ltd.
Trentham Lakes
Stoke-on-Trent
Staffordshire
ST4 4TJ

www.bfm-europe.com

Telephone - General Enquiries : (01782) 339000
Telephone - Service : (0844) 7700169