



OPERATING INSTRUCTION MANUAL



Dimplex Optiflame Wall Fire

Models: Toluca TLC20

EN: This product is only suitable for well insulated rooms or occasional use. DE: Dieses Produkt ist nur für gut isolierte Bereiche oder gelegentliche Verwendung geeignet. FR: Ce produit convient uniquement à des endroits bien isolés ou pour un usage occasionnel. IT: Questo prodotto è adatto solo per spazi ben isolati o per uso occasionale. ES: Este producto sólo es adecuado para espacios bien aislados o un uso ocasional. NL: Dit product is uitsluitend geschikt voor goed geïsoleerde ruimten of voor sporadisch gebruik. PL: Produkt ten jest odpowiedni wyłącznie do dobrze odizolowanych miejsc lub do okazjonalnego użytku. NO: Dette produktet egner seg kun for godt isolerte rom eller sporadisk bruk. RO: Acest produs este adecvat exclusiv spațiilor bine ventilate sau utilizării ocazionale. CZ: Tento výrobek je vhodný pouze do dobře izolovaných prostor nebo k příležitostnému použití. DK: Dette produkt er kun egnet til velisolerede rum eller lejlighedsvis brug. PT: Este produto somente é adequado para espaços bem isolados ou uso ocasional. SE: Denna produkt är endast avsedd för välisolerade utrymmen eller tillfällig användning. FI: Tämä tuote soveltuu ainoastaan hyvin eristettyihin tiloihin tai satunnaiseen käyttöön. SK: Tento výrobok je vhodný len pre dobre izolované priestory alebo na občasné použitie. SI: Ta izdelek je primeren le za dobro izolirane prostore ali za občasno uporabo. HR: Ovaj proizvod je pogodan samo za dobro izolirane prostore ili povremenu upotrebu. HU: Ez a termék csak jól szigetelt terekhez vagy eseti használatra alkalmas



The product complies with the required Product Safety, Electromagnetic Compatibility and Environmental Standards. This product is fully compliant with LVD, EMC, RoHs and EcoDesign Directives

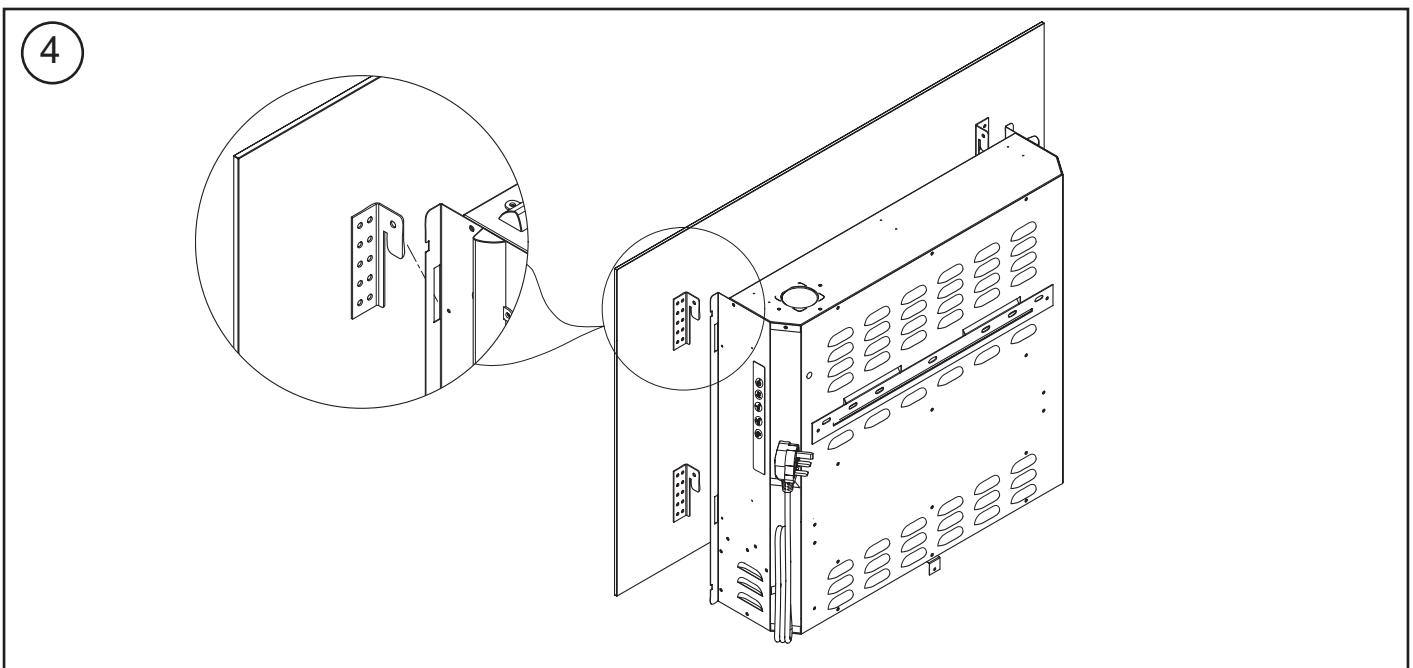
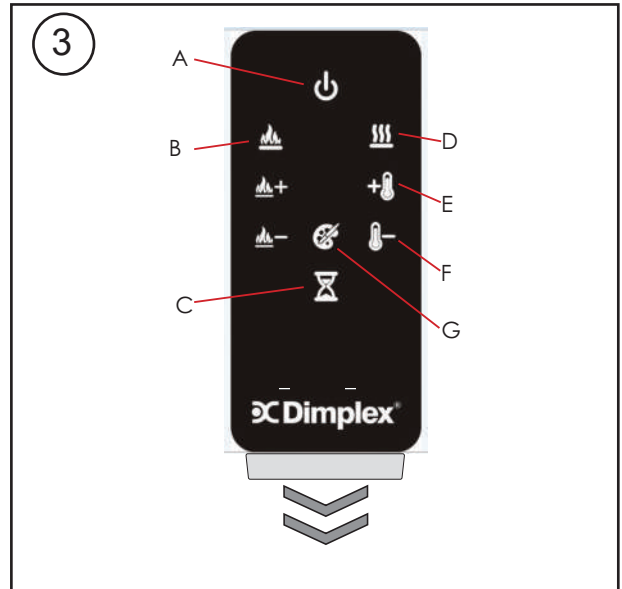
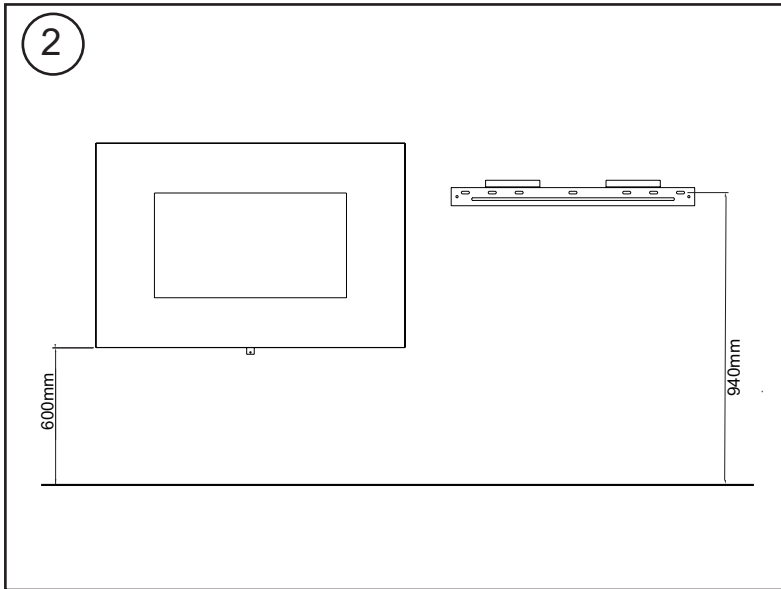
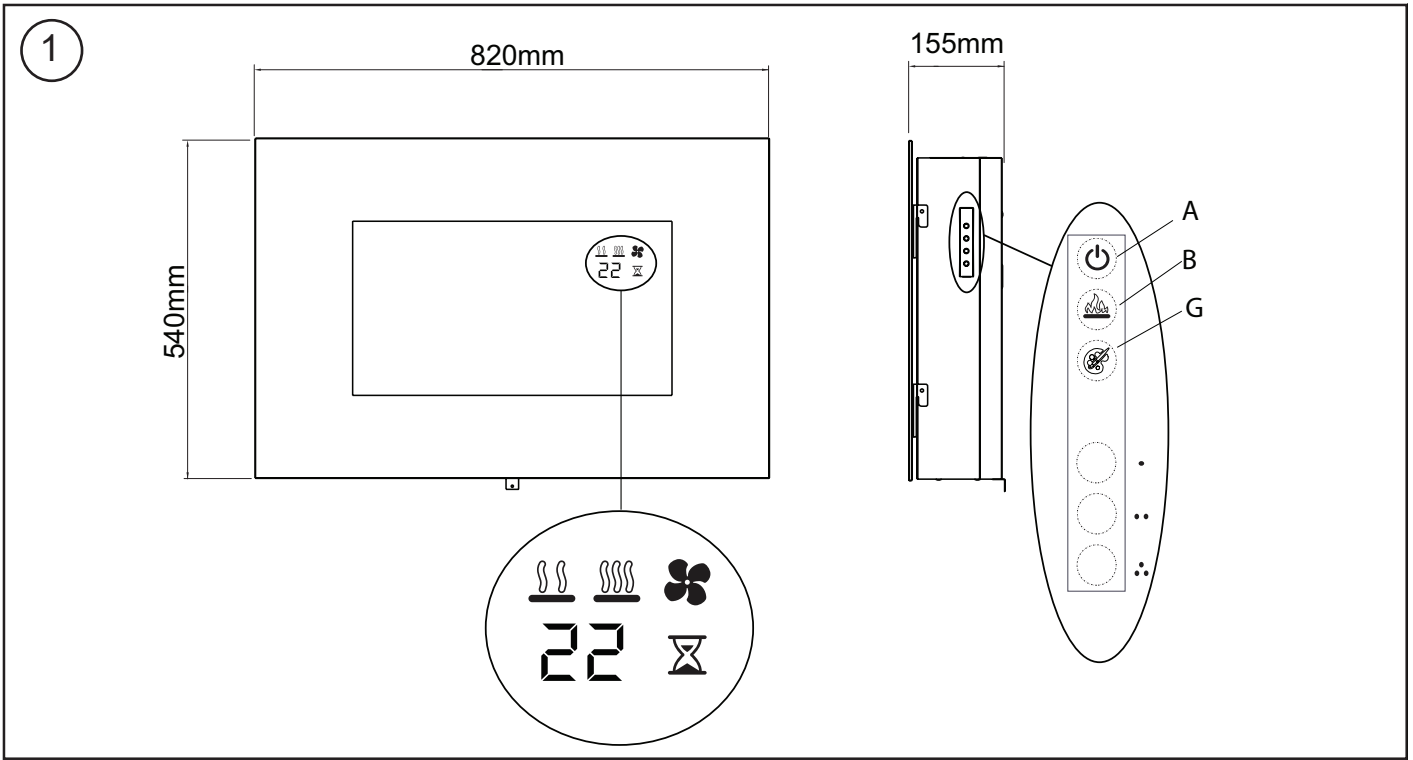

CAUTION: FAILURE TO FOLLOW THESE INSTRUCTIONS MAY CAUSE INJURY AND/OR DAMAGE AND MAY INVALIDATE YOUR GUARANTEE

Important Safety Advice

When using electrical appliances, basic precautions should always be followed to reduce the risk of fire, electrical shock and injury to persons, including the following:

- If the appliance is damaged, check with the supplier before installation and operation.
- Do not use outdoors.
- Do not use in the immediate surroundings of a bath, shower or swimming pool.
- Do not locate the appliance immediately above or below a fixed socket outlet or connection box.
- Do not use this heater if it has been dropped.
- Do not use if there are visible signs of damage to the heater.
- Use this heater on a horizontal and stable surface, or fix it to the wall, as applicable

Warning: This heater must not be used for anything other than normal domestic household purposes in the country where it was purchased from a recognised commercial retailer.

This appliance can be used by children aged from 8 years and above and persons with reduced physical, sensory or mental capabilities, or lack of experience and knowledge as long as they have been given supervision or instruction concerning use of the appliance in a safe way and understand the hazards involved. Children shall not play with the appliance. Cleaning and user maintenance shall not be undertaken by children without supervision.

Children of less than 3 years should be kept away from the appliance unless continuously supervised. Children aged from 3 years and less than 8 years shall only switch on/off the appliance, provided that it has been placed or installed in its intended normal operating position and they have been given supervision or instruction concerning use of the appliance in a safe way and understanding the hazards involved. Children aged from 3 years and less than 8 years shall not plug in, regulate and clean the appliance or perform user maintenance.

Do not use this appliance in series with a thermal control, a program controller, a timer or any other device that switches on the heat automatically, since a fire risk exists when the appliance is accidentally covered or displaced.

In the event of a fault, unplug the appliance. Unplug the appliance when not required for long periods.

The appliance must be positioned so that the plug is accessible. If the supply cord is damaged it must be replaced by the manufacturer or service agent or a similarly qualified person in order to avoid a hazard. Keep the supply cord away from the front of the appliance.

Warning: Do not use this heater in small rooms when they are occupied by persons not capable of leaving the room on their own, unless constant supervision is provided.

Warning: To reduce the risk of fire, keep textiles, curtains, or any other flammable material a minimum distance of 1m from the air outlet.

Caution: Some parts of this product can become very hot and cause burns. Particular attention has to be given where children and vulnerable people are present. This instruction can be found at www.dimplex.co.uk

Warning: In order to avoid overheating, do not cover the heater. Do not place material or garments on the appliance, or obstruct the air circulation around the appliance, for instance by curtains or furniture, as this could cause overheating and a fire risk.

The appliance carries a Do Not Cover label or the Warning Symbol shown here on the right. This symbol indicates that it must not be covered. Do not cover or obstruct the heat outlet grill in any way. This is located above the flame window on the appliance.



Warning: In order to avoid a hazard due to inadvertent resetting of the thermal cut-out, this appliance must not be supplied through an external switching device, such as a timer, or connected to a circuit that is regularly switched on and off by the utility.

WARNING: KEEP BATTERIES OUT OF REACH OF CHILDREN

1. Swallowing may lead to serious injury in as little as 2 hours or death, due to chemical burns and potential perforation of the oesophagus.
2. If you think batteries might have been swallowed or placed inside any part of the body seek immediate medical attention
3. Examine devices and make sure the battery compartment is correctly secured, e.g. that the screw or other mechanical fastener is tightened. Do not use if the compartment is not secure.
4. Dispose of used button batteries immediately and safely. Flat batteries can still be dangerous.

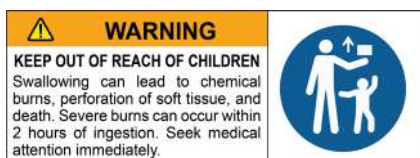

CAUTION: No obvious symptoms

Unfortunately, it is not obvious when a button or coin battery is stuck in a child's oesophagus (food pipe).

There are no specific symptoms associated with this. The child might:

- cough, gag or drool a lot;
- appear to have a stomach upset or a virus;
- be sick;
- point to their throat or stomach;
- have a pain in their abdomen, chest or throat;
- be tired or lethargic;
- be quieter or more clingy than usual or otherwise “not themselves”;
- lose their appetite or have a reduced appetite; and
- not want to eat solid food/be unable to eat solid food.

These sorts of symptoms vary or fluctuate, with the pain increasing and then subsiding.

A specific symptom to button and coin battery ingestion is vomiting fresh (bright red) blood. If the child does this seek immediate medical help.

The lack of clear symptoms is why it is important to be vigilant with “flat” or spare button or coin batteries in the home and the products that contain them.

Dimplex Optiflame Wall Fire

Models: Toluca TLC20

Thank you for choosing a Dimplex electric fire.

General Information

Unpack the heater carefully and retain the packaging for possible future use, in the event of moving or returning the fire to your supplier.

The fire incorporates a flame effect, which can be used with or without heating, so that the comforting effect may be enjoyed at any time of the year. Using the flame effect on its own only requires little electricity.

Before connecting the heater check that the supply voltage is the same as that stated on the heater.

Please note: Used in an environment where background noise is very low, it may be possible to hear a sound which is related to the operation of the flame effect. This is normal and should not be a cause for concern.

Technical Information

Model No: TLC20

Heat Output		230V	240V	
Nominal Heat Output	P_{Nom}	1.7	1.9	kW
Minimum Heat Output	P_{min}	0.9	0.9	kW
Maximum Continuous Heat Output	$P_{max,c}$	1.7	1.9	kW
Auxiliary Electricity Consumption				
In Standby Mode	$e/_{SB}$	0.48	0.49	W

with mechanic thermostat room temperature control.

Electrical connection

WARNING – THIS APPLIANCE MUST BE EARTHED.

This heater must be used on an AC ~ supply only and the voltage marked on the heater must correspond to the supply voltage. Before switching on, please read the safety warnings and operating instructions.

Installation

⚠ WARNING: FALLING OR TIPPING APPLIANCES CAN CAUSE INJURY OR DEATH OF YOUNG CHILDREN, PLEASE ENSURE CHILDREN DO NOT CLIMB, HANG OR STAND ON THIS PRODUCT.

⚠ WARNING: THE APPLIANCE IS PROVIDED WITH A WALL FIXING KIT, THIS KIT IS DESIGNED TO HOLD THE PRODUCTS WEIGHT, IT IS NOT A SUBSTITUTE FOR PROPER ADULT SUPERVISION. DO NOT ALLOW CHILDREN TO CLIMB OR HANG ON THIS PRODUCT.

Safety Message - Sufficient expertise is required for installing this product. If unsure we recommend that you use an installer and pay special attention to safety during the installation.

Wall Installation- See Fig. 2

Do not connect appliance until properly fixed to the wall and the Instruction leaflet is fully read. In particular, the minimum distances must be observed.

The wall plugs supplied with this product are for use with Block/Brick built walls only.

This model is designed to be permanently fixed to a wall at a minimum height of 300mm. The wall bracket must be fitted horizontally and the cable routed to the bottom right of the appliance.

A height of 600 to 725mm from bottom of the appliance to floor is recommended for optimum viewing of fuel bed.















For optimum viewing, mark the top three screw fixing positions on the wall in accordance with the recommended fixing dimensions - see Fig. 2. Drill holes with a 6mm drill bit.

Fix the wall bracket using the plugs and screws provided. Carefully lift the appliance up ensuring that the appliance engages with the wall bracket correctly.

A bottom fixing bracket is supplied with the unit, fixed to the base of the appliance. Remove the screw and the bracket, turn the bracket through 180 degrees so it is now facing downward and re fit using the screw just removed. With the bracket in place mark the location of the hole on the wall. Remove the appliance, drill the wall, fit the wall plug and re-fit the appliance ensuring that you secure it in place by screwing the bottom fixing bracket to the wall.

Operating The Product

Operating Instructions - See Fig. 3

	Icon	Display	Funtion	Description
A		-	Power / Standby	Press Once to turn the product 'ON'. Press a second time to put the product into 'STANDBY' (When returning from 'STANDBY' mode the product will return to previous settings unless the product has been unplugged, in which case it will reset to factory settings)
B				'FLAME EFFECT' button this turns the flame effect ON or OFF independently of the products other features.
			Flame Up	This Button will increase the brightness of the flame effect. There are 5 brightness settings shown as F1, F2, F3, F4, F5. This button will ONLY increase the brightness level.
			Flame Down	This Button will decrease the brightness of the flame effect. There are 5 brightness settings shown as F1, F2, F3, F4, F5. This button will ONLY decrease the brightness level.
		FC	Flame Cycling	This setting is set by pressing the Flame Up button once more after F5. this will cause the brightness of the flame effect to cycle from F2 to F5 in a continuous Loop.
		-	Off	This will turn the flame effect off. If the heater is ON, the display will activate and remain active to read the set temperature and show if the product is on LOW HEAT/ HIGH HEAT/ COOL BLOW.
C			Sleep Timer	Press multiple times to change the 'SLEEP TIMER' in 0.5 hr increments from 0.5 hr to 8.0 hr before turning off. The remaining time on the 'SLEEP TIMER' displays. (This icon is Green in Colour)
D				'HEAT' button cycles the unit sequentially through the 4 settings: LOW HEAT, HIGH HEAT, COOL BLOW and OFF. The heat setting will be indicated by an icon in the display see Fig.1. When the flame effect is 'ON' the display will turn off after 5 seconds, however if the heater is being used independently of the flame effect. The low heat or high heat icon will appear continuously in the display.
			Low Heat	This setting will run the heater at 'LOW HEAT' this setting will be indicated by the 'LOW HEAT' icon. To Adjust the temperature setting the Temp Down or Temp Up buttons described below must be used. (This icon is Orange in Colour)
			High Heat	This icon in the display indicates 'HIGH HEAT' this setting will be indicated by the 'HIGH HEAT' icon. To Adjust the temperature setting the Temp Down or Temp Up buttons described below must be used. (This icon is Red in Colour)
			Cool Blow	This icon in the floating display indicates 'COOL BLOW' this setting will be indicated by the 'COOL BLOW' icon and the letters 'CB' appearing in the display. (This icon is Blue in Colour)
		-	Off	This switches the heater and blower 'OFF', no icon will be displayed in the display. Note the blower will run for 5-10 seconds after being turned off, this is to ensure the product cools down safely.
E		-	Temp Up	Press multiple times to increase the heater temperature in 1 ⁰ C increments. The highest temperature that can be set 30 ⁰ C. When High Heat is selected, the letters 'HH' appear in the display, this means the heat will remain ON continuously and is not controlled by the thermostat.
F		-	Temp Down	Press multiple times to lower the heater temperature in 1 ⁰ C increments. The lowest temperature that can be set is 18 ⁰ C.
G		-	LED COLOUR	Press multiple times to change the colour of the coloured fuel bed. The colour can be set as Orange, Red, Green, Blue, or cycling through all four colours continuously.

User Modes:

Mode Name /Discription	Action (Actions cannot be input by remote control)
Change Celsius (° C) to Fahrenheit (° F)	Press both 3 Dot Button (•••) and 2 Dot (••) on the unit and hold until beep is heard and display flashes. (To revert back to Celsius repeat this action)

Operating The Product

Remote control - see Fig. 3

The maximum range of use is ~ 5metres.

Warning: It takes time for the receiver to respond to the transmitter.

Do not press the buttons more than once within two seconds for correct operation.

Battery information - see Fig. 3

1. To activate the remote control remove the battery isolation strip, which is used to ensure your remote control reaches you fully charged.
2. Remove the screw, follow the instruction on the back of the remote to release the battery housing. Slide the battery cover open. Install Lithium battery in the battery holder. The positive (+) side of the battery faces up. Close the battery cover and replace the screw
3. Only use CR2025 or CR2032 size of batteries.

Discard leaking batteries

Dispose of batteries in the proper manner according to provincial and local regulations.

Any battery may leak electrolyte if mixed with a different battery type, if inserted incorrectly, if all the batteries are not replaced at the same time, if disposed of in a fire, or if an attempt is made to charge a battery not intended to be recharged.

Fuel Bed Media

Acrylic Ice Crystals are supplied with your fire. To Fit the Acrylic Ice Crystals, place the small Crystals on the fuel bed tray, then place the larger crystals on top of the small pieces. Arrange the larger pieces to your liking. A suggestion is to place one large crystal centrally on the fuel bed and the other four positioned symmetrically around this piece.

Fitting the Front Glass- See Fig. 5

Your new fire is supplied with the front glass not secured to the engine, this is to keep the glass safe in transit. To fit the glass to your fire, simply insert the four hangers on the back of the glass through the slots provided on the chassis. The hangers go in through the slots and then move down to hold the glass in place. The glass can then be secured in place by inserting the small black screw provided through the hole in any one of the hangers into the side of the unit.

Maintenance

WARNING: ALWAYS DISCONNECT FROM THE POWER SUPPLY BEFORE CLEANING THE HEATER.

Cleaning

Before commencing cleaning, unplug the heater and allow it to cool. For general cleaning use a soft clean duster – never use abrasive cleaners. The glass viewing screen should be cleaned carefully with a soft cloth. DO NOT use proprietary glass cleaners. To remove any accumulation of dust or fluff the soft brush attachment of a vacuum cleaner should occasionally be used to clean the outlet grille of the fan heater.

Light Emitting Diode

This fire is fitted with LED (Light Emitting Diode) lamps. These LED lamps are maintenance-free and should not require replacing during the life of the product.

CAUTION: Assembly, installation and repair of this heater must be carried out by Dimplex or its authorised agent.

Thermal Safety Cut-out

The built-in overheat cut-out, switches off the appliance automatically in the event of a fault! Should this occur switch off the appliance or disconnect the mains plug from the socket.

Remove any obstructions which may have caused the overheating. After a short cooling down phase, the appliance is ready for use again! If the fault should occur again, contact your local dealer!

WARNING: In order to avoid a hazard due to inadvertent resetting of the thermal cut-out, this appliance must not be supplied through an external switching device, such as a timer, or connected to a circuit that is regularly switched on and off by the utility.

Additional Information

Recycling



At the end of the electrical products useful life it not be disposed of with household waste. Please recycle where facilities exist. Check with your Local Authority or retailer for recycling advice in your country.

After Sales Service

Your product is guaranteed for one year from the date of purchase. Within this period, we undertake to repair or exchange this product free of charge provided it has been installed and operated in accordance with these instructions. Your rights under this guarantee are additional to your statutory rights, which in turn are not affected by this guarantee.

CAUTION: Do not use if the heater's mains power lead is damaged. Such use may cause a hazard. If damaged, the mains power lead must be replaced by the manufacturer or its authorised dealer.

Should you require after sales information or assistance with this product please go to www.dimplex.co.uk and select "Customer Support" or ring our help desk on 0344 879 3588 (UK) or 01 842 8222 (R. O. I.). Spare parts are also available on the web site. Please retain your receipt as proof of purchase.

Tel: 0344 879 3588

Republic of Ireland Tel: 01 8428 222

www.dimplex.co.uk

 **Dimplex**[®]

Dimplex Millbrook House, Grange Drive, Hedge End, Southampton, SO30 2DF