



OPERATING INSTRUCTION MANUAL

Optiflame^{3D}

Dimplex Optiflame 3D Inset Fire

Models: Braemar BMR20, Dumfries DMF20, Glencoe GLN20,
Torridon TRR20, Portree POR20.

EN: This product is only suitable for well insulated rooms or occasional use. DE: Dieses Produkt ist nur für gut isolierte Bereiche oder gelegentliche Verwendung geeignet. FR: Ce produit convient uniquement à des endroits bien isolés ou pour un usage occasionnel. IT: Questo prodotto è adatto solo per spazi ben isolati o per uso occasionale. ES: Este producto sólo es adecuado para espacios bien aislados o un uso ocasional. NL: Dit product is uitsluitend geschikt voor goed geïsoleerde ruimten of voor sporadisch gebruik. PL: Produkt ten jest odpowiedni wyłącznie do dobrze odizolowanych miejsc lub do okazjonalnego użytku. NO: Dette produktet egner seg kun for godt isolerte rom eller sporadisk bruk. RO: Acest produs este adecvat exclusiv spațiilor bine ventilate sau utilizării ocazionale. CZ: Tento výrobek je vhodný pouze do dobře izolovaných prostor nebo k příležitostnému použití. DK: Dette produkt er kun egnet til velisolerede rum eller lejlighedsvis brug. PT: Este produto somente é adequado para espaços bem isolados ou uso ocasional. SE: Denna produkt är endast avsedd för välisolerade utrymnen eller tillfällig användning. FI: Tämä tuote soveltuu ainoastaan hyvin eristettyihin tiloihin tai satunnaiseen käyttöön. SK: Tento výrobok je vhodný len pre dobre izolované priestory alebo na občasné použitie. SI: Ta izdelek je primeren le za dobro izolirane prostore ali za občasno uporabo. HR: Ovaj proizvod je pogodan samo za dobro izolirane prostore ili povremenu upotrebu. HU: Ez a termék csak jól szigetelt terekhez vagy eseti használatra alkalmas

 The product complies with the European Safety Standards and the European Standard Electromagnetic Compatibility (EMC) These cover the essential requirements of EEC Directives

CAUTION: FAILURE TO FOLLOW THESE INSTRUCTIONS MAY CAUSE INJURY AND/OR DAMAGE AND MAY INVALIDATE YOUR GUARANTEE

Important Safety Advice

When using electrical appliances, basic precautions should always be followed to reduce the risk of fire, electrical shock and injury to persons, including the following:

- If the appliance is damaged, check with the supplier before installation and operation.
- Do not use outdoors.
- Do not use in the immediate surroundings of a bath, shower or swimming pool.
- Do not locate the appliance immediately below a fixed socket outlet or connection box.
- Do not use this heater if it has been dropped.
- Do not use if there are visible signs of damage to the heater.
- Use this heater on a horizontal and stable surface, or fix it to the wall, as applicable

Warning: This heater must not be used for anything other than normal domestic household purposes in the country where it was purchased from a recognised commercial retailer.

This appliance can be used by children aged from 8 years and above and persons with reduced physical, sensory or mental capabilities, or lack of experience and knowledge as long as they have been given supervision or instruction concerning use of the appliance in a safe way and understand the hazards involved. Children shall not play with the appliance. Cleaning and user maintenance shall not be undertaken by children without supervision.

Children of less than 3 years should be kept away from the appliance unless continuously supervised. Children aged from 3 years and less than 8 years shall only switch on/off the appliance, provided that it has been placed or installed in its intended normal operating position and they have been given supervision or instruction concerning use of the appliance in a safe way and understanding the hazards involved. Children aged from 3 years and less than 8 years shall not plug in, regulate and clean the appliance or perform user maintenance.

Warning: This appliance must be earthed.

The use of an extension lead or multi-plug adaptor is not advised when connecting this product to the mains. Connection through these devices could lead to a risk of overloading, overheating and even fire at the extension lead or adaptor due to inadequate connection quality.

This heater must be used on an alternating current supply (~) only and the voltage marked on the heater must correspond to the supply voltage.

Do not use this appliance in series with a thermal control, a program controller, a timer or any other device that switches on the heat automatically, since a fire risk exists when the appliance is accidentally covered or displaced.

DO NOT use the heater on deep pile carpets or the long hair type of rugs, or less than 750mm (30") away from any overhanging surface. Keep combustible materials such as drapes and other furnishings clear from the front, sides and rear of the heater. Do not use heater to dry your laundry.

In the event of a fault, unplug the appliance. Unplug the appliance when not required for long periods.

The appliance must be positioned so that the plug is accessible. If the supply cord is damaged it must be replaced by the manufacturer or service agent or a similarly qualified person in order to avoid a hazard. Keep the supply cord away from the front of the appliance.

Warning: Do not use this heater in small rooms when they are occupied by persons not capable of leaving the room on their own, unless constant supervision is provided.

Warning: To reduce the risk of fire, keep textiles, curtains, or any other flammable material a minimum distance of 1m from the air outlet.

Caution: Some parts of this product can become very hot and cause burns. Particular attention has to be given where children and vulnerable people are present. This instruction can be found at www.dimplex.co.uk

Warning: In order to avoid overheating, do not cover the appliance. Do not place material or garments on the appliance, or obstruct the air circulation around the appliance, for instance by curtains or furniture, as this could cause overheating and a fire risk. The appliance carries the Warning Symbol indicating that it must not be covered or has a Do not cover label. Do not cover or obstruct in any way the heat outlet grille located below the flame window on the appliance. Overheating will result if the appliance is accidentally covered. 

Warning: In order to avoid a hazard due to inadvertent resetting of the thermal cut-out, this appliance must not be supplied through an external switching device, such as a timer, or connected to a circuit that is regularly switched on and off by the utility.

Dimplex Optiflame 3D Inset Fire

Models: BMR20, DMF20, GLN20, TRR20, POR20

Thank you for choosing a Dimplex electric fire.

General Information

The fire incorporates a flame effect, which can be used with or without heating, so that the comforting effect may be enjoyed at any time of the year.

A fan heater can provide heating in cold weather. A distance of 1 metre (3 feet) must be maintained between the front of the heater and any surrounding furniture, overhanging curtains or other obstructions.

To reduce heat loss and to prevent any chimney up draft affecting the operation of your inset fire, we recommend that the chimney flue is sealed off.

Always ensure that the appliance is sitting on a level surface.

Before connecting the appliance, check that the supply voltage is the same as that stated on the appliance.

Please note: Used in an environment where background noise is very low, it may be possible to hear a sound which is related to the operation of the flame effect. This is normal and should not be a cause for concern.

Technical Information

Model No: Braemar BMR20BR, BMR20CH, BMR20AB, Dumfries DMF20BR, DMF20CH, DMF20AB, DMF20BL Glencoe GLN20BR, GLN20CH Torridon TRR20CH Portree POR20CH

Heat Output		230V	240V	
Nominal Heat Output	P_{Nom}	1.7	1.8	kW
Minimum Heat Output	P_{min}	0.9	1.0	kW
Maximum Continuous Heat Output	P_{max}	1.7	1.8	kW
Auxiliary Electricity Consumption				
In Standby Mode	P_{Nom}	0.02	0.02	W

With electronic room temperature control.

Installation Instructions

This heater must be used on an AC ~ supply only and the voltage marked on the heater must correspond to the supply voltage. Before switching on, please read the safety warnings and operating instructions. Please retain this user's guide for future reference

Before installing this appliance in an existing chimney, we recommend that;

1. You have your chimney cleaned by a competent chimney sweep.
2. You block off the chimney flue.

This procedure is important for the efficient operation of the heating unit and will also reduce heat loss up the chimney.

Ensure that all packing items are removed (read any warning labels carefully). Retain all packing for possible future use e.g. in the event of moving or returning the appliance to your supplier.

Installing the Appliance;

1. Clean the area where the fire will be installed e.g. remove ash residue from an existing fireplace.
2. Hold the fire by the sides of surround and gently manoeuvre into position.
3. Plug the fire into a 13amp/240 volt outlet. Ensure that the supply cable is not trapped under the fire such that it might cause it to be damaged.

At the rear of the fire, two adjustable feet are provided for levelling the fire where the fire is being installed on an uneven surface. You can adjust the feet by removing the two screws and refitting the them in the required position, one at a time.

All fires are supplied with a keyhole slot on the rear of the fire surround or spacer. A screw and rawl plug can be used in conjunction with this keyhole slot to provide extra stability to the fire and to prevent it from accidentally being knocked over. **The rawl plug supplied is suitable for use in block walls only (other wall types may need alternative fixings).**

Some models are supplied with a metal surround spacer already fitted to the product, see Fig 5. This spacer can be removed from the fire if you would like to position the fire fully inset in a fireplace. In order to remove the metal surround, unscrew the six fixing screws at the rear of the product, see Fig. 6. The steps below can be used to install the above fire models with or without the metal spacer fitted.

1. Determine whether the installation of your fire will be with/without the spacer. See Fig. 4 and Table 2 for reference to dimensions of your electric fire.
2. Measure and mark the installation position of the screws.
This position is indicated by 'Y' and 'Z' in Fig. 7 (See Table 3 for dimensions for your chosen electric fire)
3. Drill the hole for the rawl plug and position the rawl plug in the hole.
4. Insert the screw into the rawl plug to a depth great enough to allow the keyhole slot on the product to fit neatly across the screw head.
5. Position the fire alongside the screws and then lift the fire up and over the screw head so that the top edge of the slot on the fire engages behind the head of the screw.

Fuelbed Assembly

Your fire has been supplied with a range of fuelbed material, which you can arrange to your preference. All product models contain crystals, coal and logs. Some models (Glencoe, Torridon and Portree) also contain white pebbles.

Loose coals, pebbles, crystals and logs are packed separately within the carton. When the heater is installed, place the fuelbed material on the fuelbed and arrange to your liking. We recommend the following step, in order to achieve the optimal effect.

1. Place crystals on fuelbed, covering the top surface of the fuelbed. These will provide a glowing embers effect, when the flame effect is operating. See Fig.1 below.



Fig. 1

2. Add coal or pebbles on top of the crystals. Allow for spaces in between coal/pebbles, for the acrylic crystals (glowing embers). See Fig.2 below.

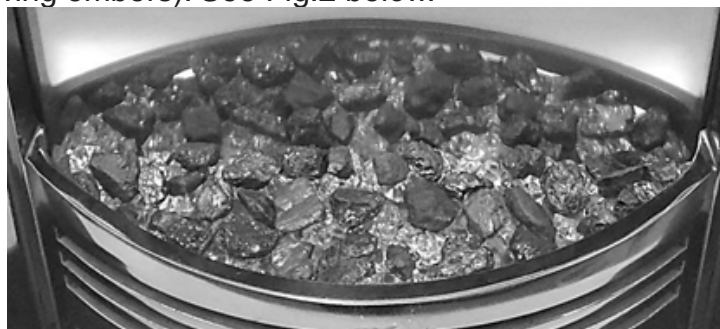

Fig. 2

3. Arrange the logs on top, to your preference. Fig.3 below displays a representation for log arrangement. You may wish not to use all of the logs provided.

















Fig. 3





Operating The Product

WARNING: FAILURE TO FOLLOW THESE OPERATING INSTRUCTIONS MAY RESULT IN INJURY AND/OR DAMAGE.





Operating Instructions (Remote Control)- See Figure 8

	Icon	Display	Funtion	Description
A		-	Power / Standby	Press Once to turn the product 'ON'. Press a second time to put the product into 'STANDBY' (When returning from 'STANDBY' mode the product will return to previous settings unless the product has been unplugged, in which case it will reset to factory settings)
B		F 1 / F 2 / F 3		'FLAME EFFECT' button this turns the flame effect ON or OFF independently of the products other features. This Button will change the brightness of the flame effect. There are 3 brightness settings shown as F1, F2, F3.
		P	Flame Pulsing	This setting is set by pressing the Flame Up button once more after F3. This will cause the brightness of the flame effect to cycle randomly, creating a flickering effect.
		-	Off	If the flame effect is turned off, but the heater is ON, the display will activate and remain active to read the set temperature and indicate if the product is on LOW HEAT/ HIGH HEAT/ COOL BLOW.
C			Sleep Timer	Press multiple times to change the 'SLEEP TIMER' in 0.5 hr increments from 0.5 hr to 8.0 hr before turning off. The remaining time on the 'SLEEP TIMER' displays. (This icon is Green in colour)
D				'HEAT' button cycles the unit sequentially through the 4 settings: LOW HEAT, HIGH HEAT, COOL BLOW and OFF. The heat setting will be indicated by an icon in the display. When the flame effect is 'ON' the display will turn off after 5 seconds, however if the heater is being used independently of the flame effect. The low heat or high heat icon will appear continuously in the display.
			Low Heat	This setting will run the heater at 'LOW HEAT' this setting will be indicated by the 'LOW HEAT' icon and the letters 'LO' appearing in the display. To adjust the temperature setting the Temp Down or Temp Up buttons described below must be used. (This icon is Orange in Colour)
			High Heat	This icon in the display indicates 'HIGH HEAT' this setting will be indicated by the 'HIGH HEAT' icon and the letters 'HI' appearing in the display. To Adjust the temperature setting the Temp Down or Temp Up buttons described below must be used. (This icon is Red in Colour)
			Cool Blow	This icon in the floating display indicates 'COOL BLOW' this setting will be indicated by the 'COOL BLOW' icon and the letters 'CB' appearing in the display. (This icon is Blue in Colour)
		-	Off	This switches the heater and blower 'OFF', no icon will be displayed in the display. Note the blower will run for 5-10 seconds after being turned off, this is to ensure the product cools down safely.
E		30	Temp Up	Press multiple times to increase the heater temperature in 2°C increments. The highest temperature that can be set 30°C. When High Heat is selected, the letters 'HH' appear in the display, this means the heat will remain ON continuously and is not controlled by the thermostat.
F		18	Temp Down	Press multiple times to lower the heater temperature in 2°C increments. The lowest temperature that can be set is 18°C.
G		-	Flame Colour	Press to turn ON/OFF the coloured accents within the flame effect.
H		-	Top-light Fuel Bed	Press to turn ON/OFF the Top light illuminating the fuel bed.
J		-	Top-light Back-ground	Press to turn ON/OFF the Top-light illuminating the product background.

Operating Instructions (On Board Controls)- See Figure 9

Icon	Description
	Press Once to turn the product 'ON'. Press a second time to put the product into 'STANDBY' (When returning from 'STANDBY' mode the product will return to previous settings unless the product has been unplugged, in which case it will reset to factory settings)
	'HEAT' switch cycles the unit sequentially through the 4 settings: LOW HEAT, HIGH HEAT, COOL BLOW and OFF. The heat setting will be indicated by an icon in the display
	Press multiple times to increase the heater temperature in 2°C increments. The highest temperature that can be set 30°C. When High Heat is selected, the letters 'HH' appear in the display, this means the heat will remain ON continuously and is not controlled by the thermostat.
	Press multiple times to lower the heater temperature in 2°C increments. The lowest temperature that can be set is 18°C.

User Modes:

Mode Name /Discription	Action (Actions cannot be input by remote control)
Disable/Enable Heat Options on product and remote control	Hold both Heat Cycle () and Temp Up () , on the product, for 5 seconds, when the heater has been disabled the display will read "--" and beep. To enable heat repeat this action.
Disable/Enable Heat Options on product only	Hold both Heat Cycle () and Temp Down () , on the product, for 5 seconds, when the heater has been disabled the product will beep. This will disable heat control functions on the product only. To enable heat repeat this action. Note: the remote control will still be able to operate heat functions.

Optimal Product Setup

When the product is switched on, the default brightness setting is F3, with all the effects operating. However, if the product is in a bright room, it is recommended that the toplights are switched off. If the product is operating in a darker room, it is recommended that the toplights are switched on, and the brightness effect is changed to Pulsing.

Please note: The product will maintain the most recent brightness settings if switched to standby. If the product is unplugged at the wall, it will revert to factory setting.

Thermal Safety Cut-out

A thermal safety cut-out is incorporated in the fan heater to prevent damage due to overheating. This can happen if the heat outlet was restricted in any way. If the cut-out operates, unplug the heater from the socket outlet and allow approximately 10 minutes before reconnecting. Before switching the heater back on remove any obstruction that may be restricting the heat outlet, then continue normal operation.

CAUTION: In order to avoid a hazard due to inadvertent resetting of the thermal cutout, this appliance must not be supplied through an external switching device, such as a timer, or connected to a switch that is regularly switched on and off by the utility.

Maintenance

WARNING: ALWAYS DISCONNECT FROM THE POWER SUPPLY BEFORE CLEANING THE HEATER.

Cleaning

Before commencing cleaning, unplug the heater and allow it to cool. The surfaces of the heater should be given an occasional wipe with a dry soft cloth. Do not use detergents, abrasive cleaning powder or furniture polish as this can damage the surface finish of the product.

The glass screen should be cleaned carefully with a chamois leather. Do not use proprietary cleaners.

To remove any accumulation of dust or fluff, the soft brush attachment of a vacuum cleaner should occasionally be used to clean the outlet grille of the fan heater located under the canopy. To clean the fuel effect, remove the coal/pebbles and wash in warm water. The plastic tray should be wiped clean with a damp cloth. When dry replace the coal/pebbles and arrange for best effect.

Led Lamps

This fire is fitted with LED (Light Emitting Diode) lamps in place of traditional incandescent bulbs. These generate the same light levels as traditional bulbs, but use a fraction of the energy consumed. These lamps cannot be replaced.

CAUTION: Assembly, installation and repair of this heater must be carried out by Dimplex or its authorised agent.

CAUTION: We recommend that you arrange for this heater to be checked annually for safety by a qualified electrician.

Additional Information

After Sales Service

Your product is guaranteed for one year from the date of purchase. Within this period, we undertake to repair or exchange this product free of charge provided it has been installed and operated in accordance with these instructions. Your rights under this guarantee are additional to your statutory rights, which in turn are not affected by this guarantee.

CAUTION: Do not use if the heater's mains power lead is damaged. Such use may cause a hazard. If damaged, the mains power lead must be replaced by the manufacturer or its authorised dealer.

Should you require after sales information or assistance with this product please go to **www.dimplex.co.uk** and select "Customer Support" or ring our help desk on 0844 879 3588 (UK) or 01 842 8222 (R. O. I.). Spare parts are also available on the web site. Please retain your receipt as proof of purchase.

Recycling



For electrical products sold within the European Community - At the end of the electrical products useful life it not be disposed of with household waste. Please recycle where facilities exist. Check with your Local Authority or retailer for recycling advice in your country.

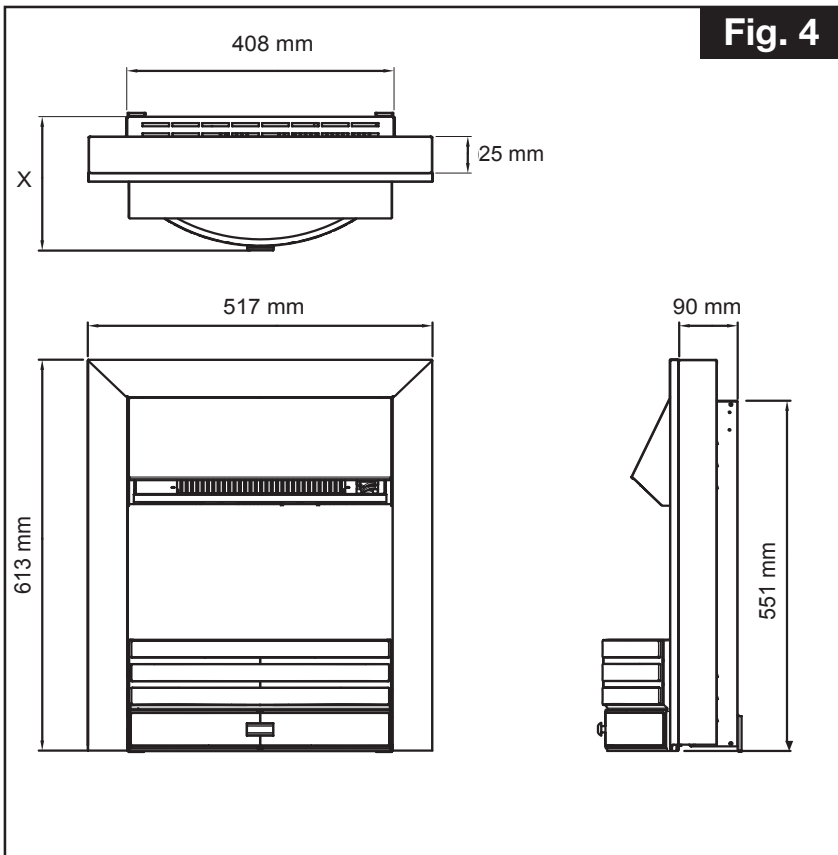

Fig. 4

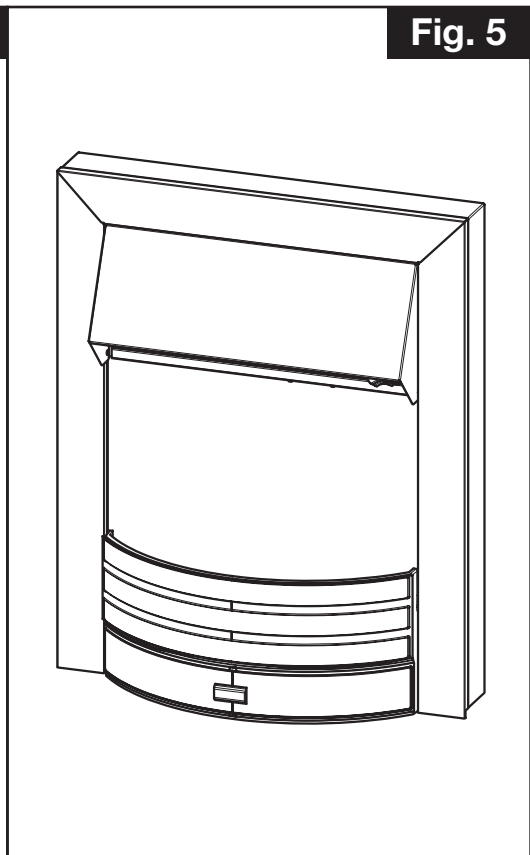

Fig. 5

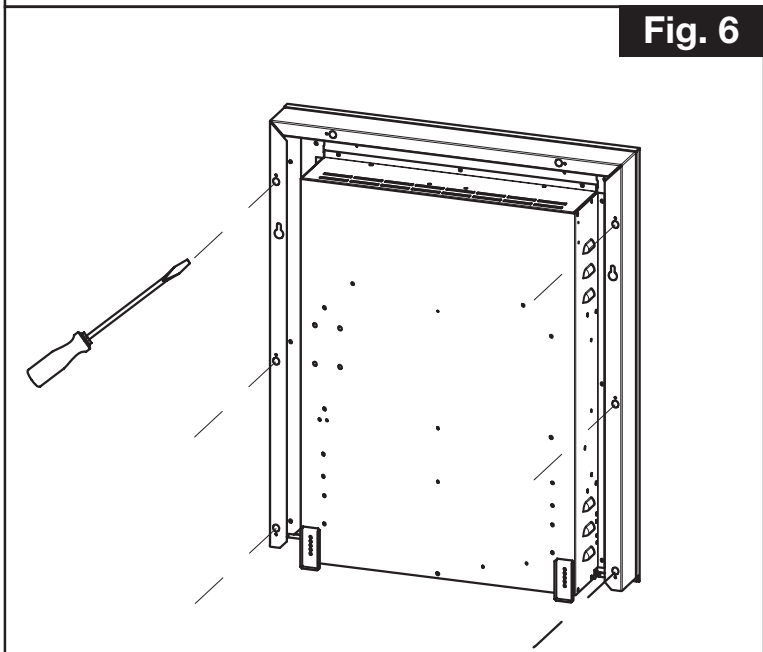

Fig. 6

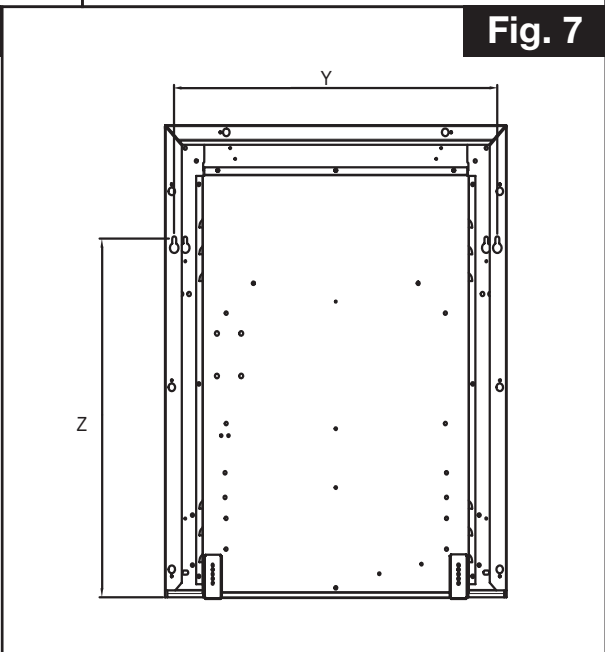

Fig. 7

TABLE 2	
	Dimension
Model Number	X (mm)
BMR20	185
DMF20	202
GLN20	218
TRR20	210
POR20	195

TABLE 3		
	Dimension	
Setup	Y (mm)	Z (mm)
With Metal Spacer	490	468
Without Metal Spacer	456	468
Glencoe models (GLN20)	490	484

Fig. 8

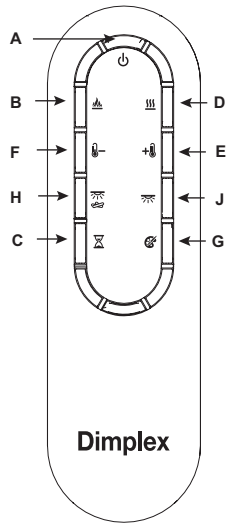

Fig. 9



Tel: 0844 879 3588
Republic of Ireland Tel: 01 8428 222
www.dimplex.co.uk



Dimplex Millbrook House, Grange Drive, Hedge End, Southampton, SO30 2DF

© Glen Dimplex Heating and Ventilation.

All rights reserved. Material contained in this publication may not be reproduced in whole or in part, without prior permission in writing of Glen Dimplex Heating and Ventilation.