

Dimplex

Belgravia Opti-V Stove

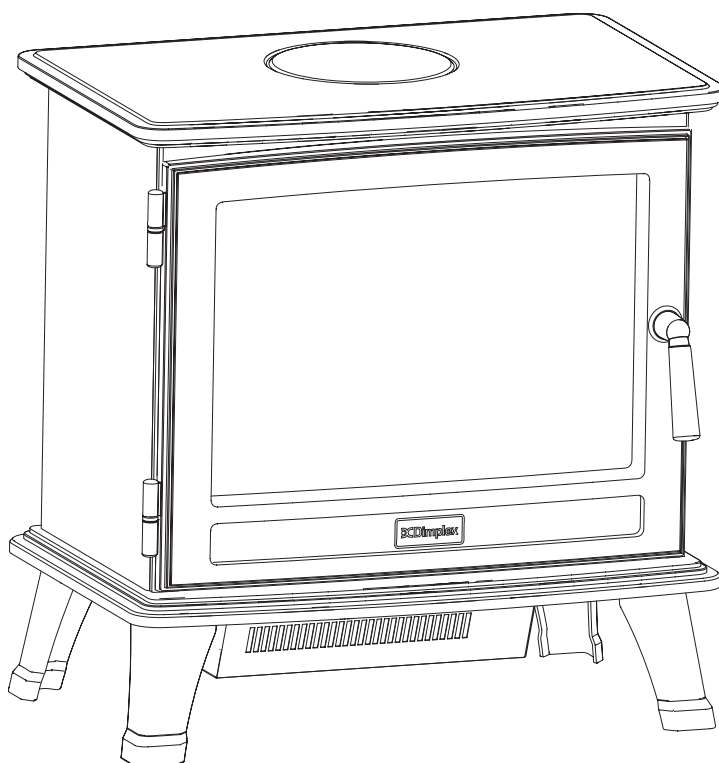

Model : BLG20 Instructions

EN

NL

FR

IT

DE

PL

ES

EN : This product is only suitable for well insulated rooms or occasional use. DE : Dieses Produkt ist nur für gut isolierte Bereiche oder gelegentliche Verwendung geeignet. FR : Ce produit convient uniquement à des endroits bien isolés ou pour un usage occasionnel. IT : Questo prodotto è adatto solo per spazi ben isolati o per uso occasionale. ES : Este producto sólo es adecuado para espacios bien aislados o un uso ocasional. NL : Dit product is uitsluitend geschikt voor goed geïsoleerde ruimten of voor sporadisch gebruik. PL : Produkt ten jest odpowiedni wyłącznie do dobrze odizolowanych miejsc lub do okazjonalnego użytku. NO : Dette produktet egner seg kun for godt isolerte rom eller sporadisk bruk. RO : Acest produs este adecvat exclusiv spațiilor bine ventilate sau utilizării ocazionale. CZ : Tento výrobek je vhodný pouze do dobře izolovaných prostor nebo k příležitostnému použití. DK : Dette produkt er kun egnet til velisolerede rum eller lejlighedsvis brug. PT : Este produto somente é adequado para espaços bem isolados ou uso ocasional. SE : Denna produkt är endast avsedd för välisolerade utrymmen eller tillfällig användning. FI : Tämä tuote soveltuu ainoastaan hyvin eristettyihin tiloihin tai satunnaiseen käyttöön. SK : Tento výrobok je vhodný len pre dobre izolované priestory alebo na občasné použitie. SI : Ta izdelek je primeren le za dobro izolirane prostore ali za občasno uporabo. HR : Ovaj proizvod je pogodan samo za dobro izolirane prostore ili povremenu upotrebu. HU : Ez a termék csak jól szigetelt terekhez vagy eseti használatra alkalmas.



This Product complies with all the Product Safety, Electromagnetic Compatibility and Environmental Standards. This product is fully compliant with the LVD, EMC, RoHS and Eco Design Directives.

EN	1
NL	5
FR	9
IT	13
DE	17
PL	21
ES	25

Introduction

Please read this information guide carefully to be able to safely install, use and maintain your product.

Important Safety Advice

When using electrical appliances, basic precautions should always be followed to reduce the risk of fire, electrical shock and injury to persons, including the following:

If the appliance is damaged, check with the supplier before installation and operation.

Do not use outdoors.

Do not use in the immediate surroundings of a bath, shower or swimming pool.

Do not locate the appliance immediately below a fixed socket outlet or connection box.

This appliance can be used by children aged from 8 years and above and persons with reduced physical, sensory or mental capabilities or lack of experience and knowledge if they have been given supervision or instruction concerning use of the appliance in a safe way and understand the hazards involved. Children shall not play with the appliance. Cleaning and user maintenance shall not be made by children without supervision.

Children of less than 3 years should be kept away unless continuously supervised.

Children aged from 3 years and less than 8 years shall only switch on/off the appliance provided that it has been placed or installed in its intended normal operating position and they have been given supervision or instruction concerning use of the appliance in a safe way and understand the hazards involved. Children aged from 3 years and less than 8 years shall not plug in, regulate and clean the appliance or perform user maintenance.

CAUTION: Some parts of this product can become very hot and cause burns. Particular attention has to be given where children and vulnerable people are present.

Do not use this appliance in series with a thermal control, a program controller, a timer or any other device that switches on the heat automatically, since a fire risk exists when the heater is accidentally covered or displaced.

Ensure that furniture, curtains or other combustible materials are positioned no closer than 1 meter from the appliance.

In the event of a fault unplug the appliance.

Unplug the appliance when not required for long periods.

Although this appliance complies with safety standards, we do not recommend its use on deep pile carpets or on long hair type of rugs.

The appliance must be positioned so that the plug is accessible.

If the supply cord is damaged it must be replaced by the manufacturer or service agent or a similarly qualified person in order to avoid a hazard.

Keep the supply cord away from the front of the appliance.

WARNING: In order to avoid overheating, do not cover the appliance. Do not place material or garments on the appliance, or obstruct the air circulation around the appliance.

The appliance carries a 'DO NOT COVER' warning label.

In order to avoid a hazard due to inadvertent resetting of the thermal cut-out, this appliance must

Electrical Connection

WARNING – THIS APPLIANCE MUST BE EARTHED

This heater must be used on an AC ~ supply only and the voltage marked on the heater must correspond to the supply voltage.

Connect the power cable to the power connector at the back of the fire. Place the stove against the wall (ensuring a 60mm gap, see * Fig. 1). Connect the plug to mains supply.

Before switching on, please read the safety warnings and operating instructions

Installation

Before installing this appliance in an existing chimney, we recommend that;

You have your chimney cleaned by a competent chimney sweep.

You block off the chimney flue.

This procedure is important for the efficient operation of the heating unit and will also reduce heat loss up the chimney.

Positioning the Stove :

The Opti-V Stove uses an illusionary reflection technique and is designed to work best when ambient light levels are low. There is an LED above the Logs which is controlled by a dimmer, that allows the brightness of the logs to be adjusted, to create the perfect flame effect to suit your environment or in areas where the ambient light levels are normal.

A minimum gap of 60mm, at the back of the product (see * Fig.1), should be maintained in order for the electronic thermostat to have optimum effect.

Operating the Stove

This section describes how to activate your Stove using either the remote control or manual controls.

The mains switch (**Fig. 3a**) controls the electricity supply to the Stove.

Note: The mains switch must be in the on (I) position for the Stove to operate either with or without heat.

The switch is located on the front panel behind the door. Open the door to access the switch - see **Fig. 3**.

When activated the logbed will light up and after approximately 7 seconds the flame picture will appear.

The user may notice a blank screen for approximately 2-3 seconds, every 30 minutes. This is normal and should not be a cause for concern.

Remote Control :

To activate the remote control, remove the battery clear, plastic strip, which is used to ensure the remote is fully charged before use - see **Fig. 2**.

To operate, aim the remote control to the front of the appliance. Press the standby button (⏻) on the remote control to leave the Stove in standby mode - indicated by a red light. Press the standby button to activate flame effect and /or heat.

The audio volume (fire sound) may be adjusted by pressing the volume control buttons : 🔊 volume down and 🔊 volume up.

Logbed Ambience :

The Stove has an LED that brightens the logbed. For your preference, the brightness can be adjusted by pressing 🔆 button to brighten and the 🌙 button to dim/turn off the LED. An audio 'beep' can be heard with each press and will stop when maximum or minimum is reached.

Heating :

To activate the heating, (ensure stove is not in standby mode) press the heat on button (🔥) once for half heat (900W) - indicated by 2 audio 'beeps'. For full heat (1800W) press again - indicated by 3 audio 'beeps'. Each press of this button activates half heat or full heat - 2 audio 'beeps' for half heat and 3 audio 'beeps' for full heat.

To turn the heat off press the heat off button (🔥) - indicated by one audio 'beep'. (The fan continues to run for approximately 10 seconds).

Electronic Thermostat :

The heating is controlled by the electronic thermostat. The default setting is '22' - see **Fig. 3b**. When the heat is activated, the heating will turn off, when the thermostat senses the temperature is at '22'. The heating will be activated again, when the thermostat senses that the temperature is less than '22'. This (room temperature) figure can be changed by pressing the temperature down button (⬇️) to reduce the room temperature (min 15) or the temperature up button (⬆️) to increase the room temperature (max 30). An audio 'beep' can be heard with each press and will stop when maximum or minimum is reached.

Note : the heating will only operate when the mains switch (**Fig. 3a**) is in the on (I) position and the room temperature is lower than the electronic set temperature.

For battery replacement refer to the embossed diagram on the back of the remote control.









NOTE - Use Lithium batteries only - CR2025

Attention should be drawn to the environmental aspects of battery disposal.

Manual Control :

The manual controls are located on the lower front panel behind the door of the stove - see **Fig. 2**.

The button functions are as remote control, described below;

-  Standby
-  Volume down
-  Volume up
-  Heat off
-  Heat on (half/full)
-  Logbed ambience dim
-  Logbed ambience brighten
-  Temperature down
-  Temperature up

Cleaning

Warning – Always press the mains switch to the ‘OFF’ (0) position - see Fig.3a and disconnect from the power supply before cleaning the fire.

For general cleaning use a soft clean duster – never use abrasive cleaners.

Additional Information

AFTER SALES SERVICE

Your product is guaranteed for one year from the date of purchase. Within this period, we undertake to repair or exchange this product free of charge, provided it has been installed and operated in accordance with these instructions. Your rights under this guarantee are additional to your statutory rights, which in turn are not affected by this guarantee.

Should you require after sales information or assistance with this product please go to www.dimplexfires.com and select “Customer Support” or ring our help desk on 0344 879 1227 (UK) or 01 842 4833 (R. O. I.). Spare parts are also available on the web site. Please retain your receipt as proof of purchase.

RECYCLING



For electrical products sold within the European Community - At the end of the electrical products useful life it should not be disposed of with household waste. Please recycle where facilities exist. Check with your Local Authority or retailer for recycling advice in your country.

Troubleshooting

Product not working :

Check mains lead ‘kettle’ connection.

Check mains switch is on.

Check socket switch is on.

Flame Picture stops:

Switch appliance to standby and switch back on.

Picture will resume after approx 7 seconds.

Heat not working:

Check room temperature setting is not below actual room temperature.

Refer to ‘Electronic Thermostat’ section.

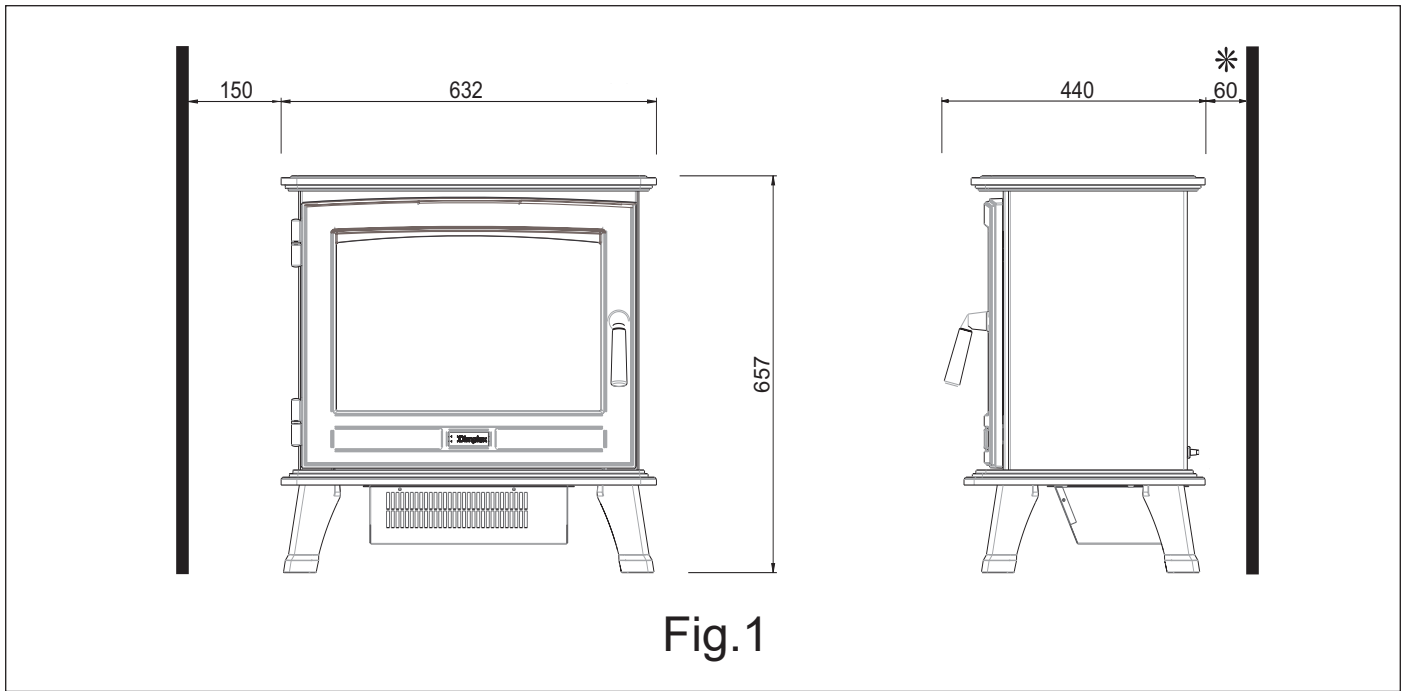

Fig. 1

Fig. 2

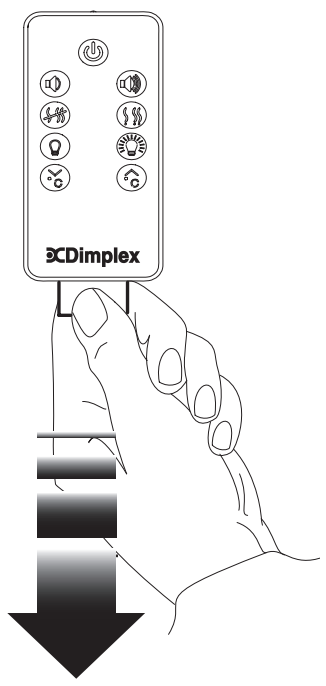

Fig. 3

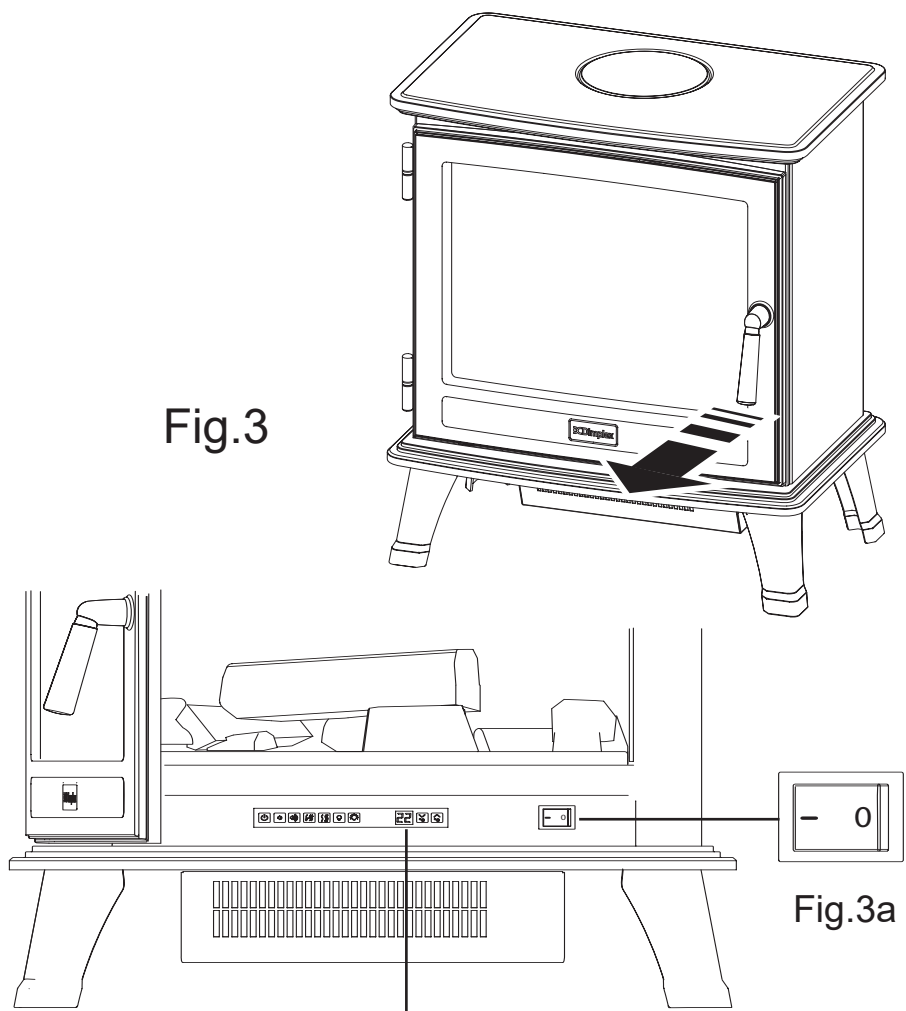

Fig. 3a

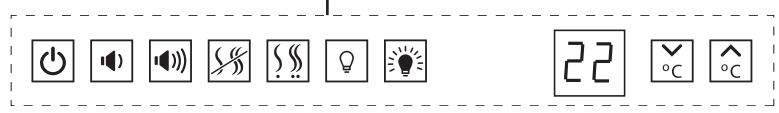

Fig. 3b