

THE  
**GALLERY**  
COLLECTION

# Solano

PREMIUM ELECTRIC STOVE

INSTRUCTION MANUAL AND USER GUIDE

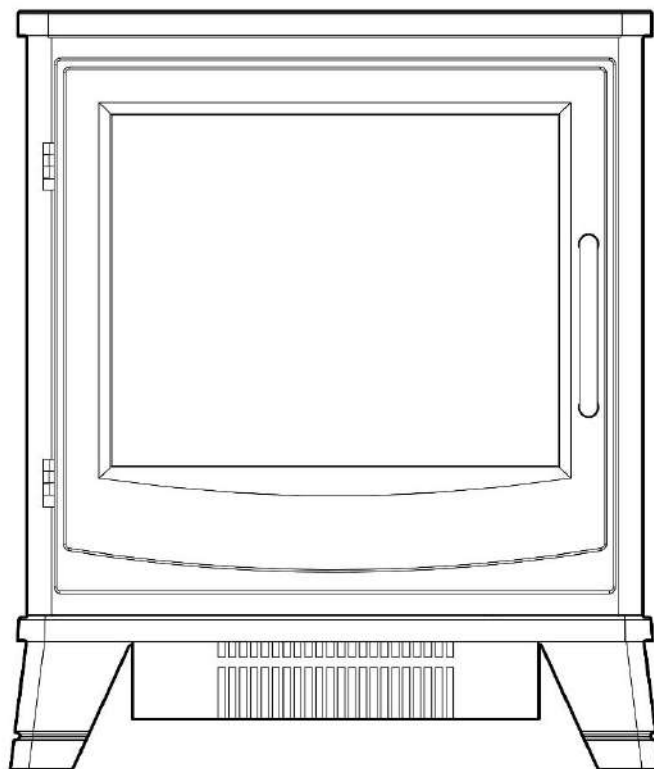

PLEASE READ THESE INSTRUCTIONS CAREFULLY BEFORE INSTALLATION AND OPERATION. KEEP THEM IN A SAFE PLACE FOR FUTURE REFERENCE

UK  
CA

CE

REV A 05/22

## IMPORTANT INFORMATION

**Before installation, check that all parts included are undamaged. If the appliance is damaged, check with the supplier before installation and operation. If the supply cord is damaged, it must be replaced by the manufacturer, its service agent or similarly qualified persons in order to avoid a hazard.**

**CAUTION:** In order to avoid a hazard due to the inadvertent resetting of the thermal cut-out, this appliance must not be supplied through an external switching device, such as a timer, or connected to a circuit that is regularly switched on and off by the utility.

**Do not** use the appliance outdoors.

**Do not** use the appliance in the immediate surroundings of a bath, a shower or a swimming pool.

**Do not** leave the appliance unattended during use.

**Do not** run the mains cable under carpet, rugs, etc.

**Do not** locate the appliance immediately below a fixed socket outlet or connection box.

**Do not** install the appliance using an extension cord.

**Do not** install the appliance in an open flue.

**Do not** insert any objects into the appliance.

**Do not** operate the appliance near flammable materials or fire.

**Do not** clean the appliance with abrasive cleaners.

**Do not** use this fire in rooms that have explosive gas in them (for example petrol), or if you are using solvents, glue, aerosol spray or in flammable paints, as these may catch fire.

**Do not** use this appliance in small rooms when they are occupied by persons not capable of leaving the room on their own, unless constant supervision is provided.

**Do** switch off and unplug the appliance from the main socket when not in use or before cleaning and maintenance.

**Do** keep the appliance away at least 1 meter from furniture, curtains or other combustible material when in use.

**Do** ensure the plug remains easily accessible after installation of the appliance.

**Do** use this appliance on a horizontal and stable surface.

## IMPORTANT INFORMATION

**CAUTION:** Some parts of this product can become very hot and cause burns. Particular attention has to be given where children and vulnerable people are present.

Children of less than 3 years should be kept away from the products unless continuously supervised. Children aged from 3 years and less than 8 years shall only switch on/off the appliance provided that it has been placed in its intended normal operating position and they have been given supervision or instruction concerning use of the appliance in a safe way and understand the hazards involved. Children aged from 3 years and less than 8 years shall not plug in, regulate and clean the appliance or perform user maintenance.

**NOTE:** A dedicated, properly fused 13 Amp circuit is required, rated for the appropriate voltage (230-240V). An isolation switch should also be incorporated in cases where the product plug is inaccessible after installation.

**NOTE:** This appliance must be earthed.

**WARNING!** Construction and wiring (including electrical safe zones) must comply with local building codes and other applicable regulations to reduce the risk of fire, electric shock and injury to persons.

**WARNING!** To reduce the risk of fire, electric shock or injury to persons, always use a licensed electrician.

**WARNING!** Information for authorized person or service center only: A non-rewireable plug fitted with a 13A fuse is supplied. Should the fuse or plug need replacing, and you are competent to do so, it must be replaced with a 13A fuse or plug being 13A BS1363A approved.

**WARNING:** In order to avoid overheating, do not cover the heater or air vents located on the appliance or obstruct the air circulation around the appliance.



**WARNING! DO NOT COVER**

## TECHNICAL INFORMATION

HEAT OUTPUT	VALUE	UNIT
Supply Voltage	230-240 (AC/50Hz)	V
Max.Power Consumption	2000	W
Power for Flame Effect	25	W
Power for Ambient Light Kit	9.6	W

HEAT OUTPUT	SYMBOL	VALUE	UNIT
Nominal Heat Output	$P_{nom}$	1.8-2	kW
Minimum Heat Output	$P_{min}$	1	kW
Maximum Continuous Heat Output	$P_{max}$	2	kW

AUXILIARY ELECTRICITY CONSUMPTION			
At Nominal Heat Output	$e_{lmax}$	12.5	W
At Minimum Heat Output	$e_{lmin}$	12	W
In Standby Mode	$e_{lsb}$	2.1	W

TYPE OF HEAT OUTPUT / ROOM TEMPERATURE CONTROL	YES / NO
Single stage heat output and no room temperature control	NO
Two or more manual stages, no room temperature control	NO
With mechanic thermostat room temperature control	NO
With electronic room temperature control	YES
Electronic room temperature control plus day timer	YES
Electronic room temperature control plus week timer	YES

OTHER CONTROL OPTIONS	YES / NO
Room temperature control, with presence detection	NO
Room temperature control, with open window detection	YES
With distance control option	YES
With adaptive start control	YES
With working time limitation	NO
With black bulb sensor	NO

ITEMS	MAIN CONTROL BOARD	WiFi MODULE	REMOTE CONTROL
Hardware	RC01-067A01-V0.0	WR3 V1.0	RF455H-V0.0
Software/Logic	TC01-067A01-V1.0	/	RCS20-V1.0
Frequency	FSK 433.92MHz/2.4GHz	2.4GHz	FSK 433.92MHz
Maximum Transmit Power	10mW	100mW	10mW

## CONTENTS

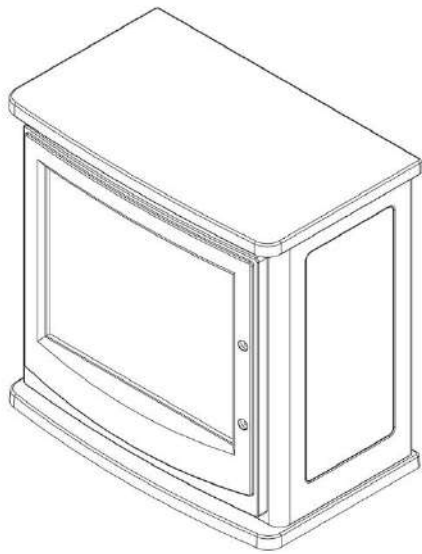

STOVE BODY



REMOTE

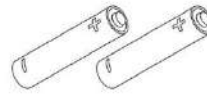

BATTERY (X2)

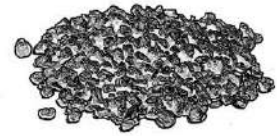

VERMICULITE GRANULES

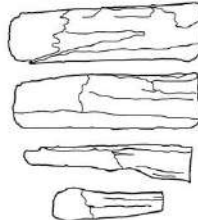

LOGS

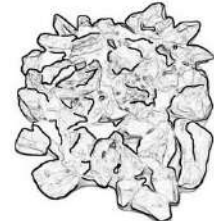

EMBERS



LOG BAR



LEG (X4)



DOOR HANDLE

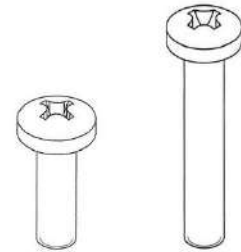

SCREW A (X4)

SCREW B (X1)

## ASSEMBLY

### LEGS

Carefully position the stove upside down, ensuring that the surface underneath is free from debris, to avoid scratches or other potential damage to the stove top. A soft carpet of towel will be ideal. Offer each of the legs into position so that the two locating pegs on each leg fits securely into the corresponding holes on the underside of the stove. Finally secure using 4 x Screw A. When finished, carefully return the stove to an upright orientation.

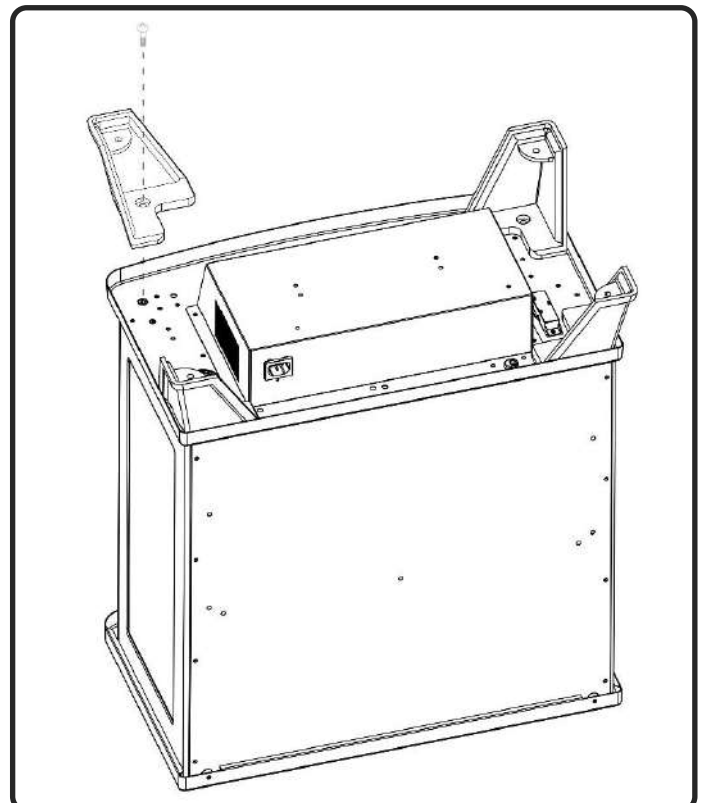

## DOOR HANDLE

Open the stove door and position the handle against the front of the door.

Take 2 x Screw B and push from behind, through the holes in the stove door, using a screwdriver to secure to the handle on the other side.

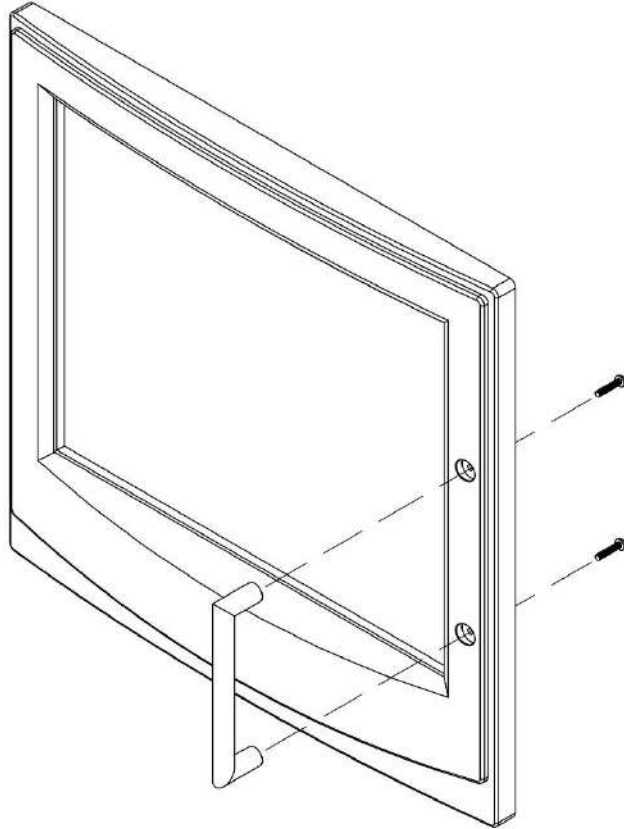

## FUEL SETUP

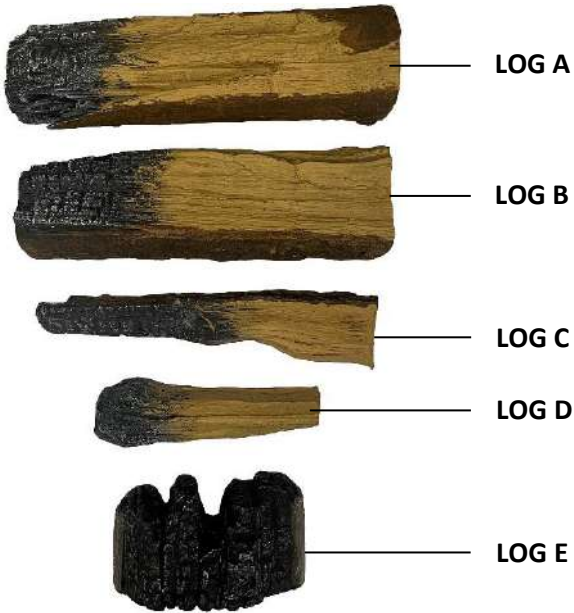

### STEP 1



Place **Log E** into the centre of the fuel bed area.

### STEP 2



Distribute the **Embers** around the fuel bed then scatter an amount of **Vermiculite Granules** on top of the embers. It is not necessary to use all the embers and vermiculite supplied.

### STEP 3



Locate the two tabs on either side of the door opening and slot the **Log Bar** into the stove. The log bar should sit firmly down onto the bottom edge of the opening.

## FUEL SETUP CONTINUED

### STEP 4



Place **Log C** into the stove as shown on the image above. The left side of the log should be positioned towards the rear, left side of the fuel bed. The right side of the log should rest on the centre of Log E.

### STEP 5



Place **Log D** into the stove as shown on the image above. The left side of the log (there is charring on the left side of the log) should rest on the centre of Log E. The right side of the log should be positioned towards the front, right side of the fuel bed.

### STEP 6



Place **Log B** into the stove as shown on the image above. The left side of the log should be positioned towards the front, left side of the fuel bed. The log should be angled towards the rear of the fuel bed, resting upon Log C.

### STEP 7



Place **Log A** into the stove as shown on the image above. The right side of the log should be positioned towards the rear, right side of the fuel bed. The log should be angled towards the front of the fuel bed, resting upon Log D .



## OPERATION

The stove can be operated conveniently in 3 different ways: manually, via the remote control handset or via the dedicated iOS/Android app.

### MANUAL CONTROL

The manual control buttons are located inside the stove on the panel directly behind the stove door.

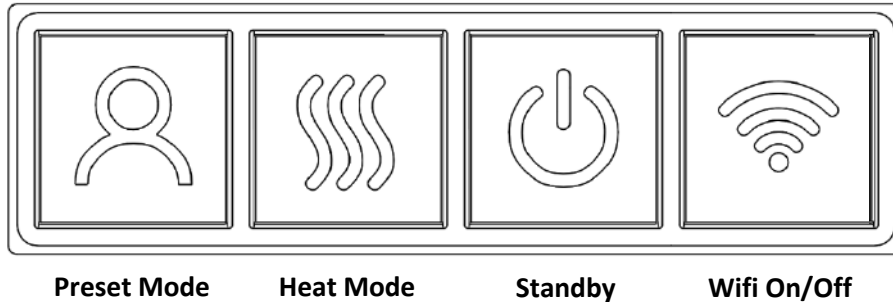

Each time a button is pressed on the appliance or on the remote control an audible beep is emitted. To turn off this feature hold your finger on the Preset Mode button (on the appliance) for 3 Seconds.

#### Wifi On/Off

Press to turn wifi on or off. An illuminated LED on the button indicates that wifi is turned on. Hold button for 3 seconds to enter device pairing mode.

#### Standby

Turns on the appliance with the last used settings without any heat. Places the appliance into standby mode with all features turned off.

#### Heat Mode

1 press = cool blow. 2 press = low heat setting. 3 press = high heat setting. 4 press = no heat/no cool blow.

#### Preset Mode

Press repeatedly to cycle through the 6 fire preset modes (+3 user defined presets if programmed).

### REMOTE CONTROL

Ensure that 2 AAA batteries are inserted into the remote control handset. The battery power level is indicated by the column of bars to the right side of the temperature display when the appliance is in standby mode. 5 bars indicates the batteries are full, 1 bar indicates the batteries are empty and need to be replaced immediately.

#### Remote Control Setup

Press and hold the Standby button on the appliance until you hear two beeps, release the button. Press Standby button on the remote control handset and you will hear one beep. The remote is connected with the appliance.

**IMPORTANT: The remote control handset must be left in the same room as the appliance as it houses the thermostat that regulates heat output.**

## OPERATION CONTINUED

### Button 1: Preset Mode

Repeatedly press to cycle through the 6 preset fire Modes (+ 3 user defined presets if programmed).

On screen Pr.1 = Autumn Campfire

On screen Pr.2 = Ember Glow

On screen Pr.3 = Inferno

On screen Pr.4 = Noir

On screen Pr.5 = Fire & Ice

On screen Pr.6 = Nebula

On screen Pr.7 = User Preset

On screen Pr.8 = User Preset

On screen Pr.9 = User Preset

There are 3 preset slots allocated for the user to Save personalised e-fire creations. Simply choose the flame colour and brightness level, the fuel bed colour and brightness level and fuel bed down light colour and brightness level. Once you have selected your desired combination, press and hold the Preset Mode button for 3 seconds until the LCD displays Pr.7. Press – and + buttons to select a slot number between 7-9. Press and hold the Preset Mode button for 3 seconds to confirm the preset.

### Button 2: Standby

Turns on the appliance with the last used settings without any heat. Places the appliance into standby mode with all features turned off.

### Button 3&9: Minus & Plus

Use to navigate through different on-screen menus.

### Button 4: Flame Speed

Press once to enter flame speed menu – SPd will show on the LCD screen. Press the plus and minus buttons to adjust the flame speed. The flame speed is indicated on screen by bars – 1 bar is the slowest setting; 5 bars is the fastest setting.

### Button 5: Flame Colour

Repeatedly press to cycle through flame colour menu. Whilst in the flame colour menu, press the plus and minus buttons to increase and decrease the flame brightness - 1 bar is the dimmest setting, 5 bars is the brightest setting.

On screen FL.0 = Flame off

On screen FL.1 = Red

On screen FL.2 = Orange

On screen FL.3 = Yellow

On screen FL.4 = Green

On screen FL.5 = Light Blue

On screen FL.6 = Dark Blue



## OPERATION CONTINUED

**On screen FL.7 = Violet**

**On screen FL.8 = White**

**On screen FL.9 = Multi-colour change**

### **Button 6: Fuel Bed Colour**

Repeatedly press to cycle through fuel bed colour menu. Whilst in the fuel bed colour menu, press the plus and minus buttons to increase and decrease the fuel bed brightness - 1 bar is the dimmest setting, 5 bars is the brightest setting.

**On screen Fb.0 = Fuel bed off**

**On screen Fb.1 = Red**

**On screen Fb.2 = Orange**

**On screen Fb.3 = Yellow**

**On screen Fb.4 = Green**

**On screen Fb.5 = Light Blue**

**On screen Fb.6 = Dark Blue**

**On screen Fb.7 = Violet**

**On screen Fb.8 = White**

**On screen Fb.9 = Multi-colour change**

### **Button 7: Timer Mode**

Repeatedly press to cycle through timer options. Select an amount of time for the appliance to operate then automatically turn off. Choose between 0.5, 1, 2, 3, 4, 5, 6, 7, 8, 9 hours.

### **Button 8: Fuel Bed Down Light**

Repeatedly press to cycle through fuel bed down light colour menu. Whilst in the fuel bed down light colour menu, press the plus and minus buttons to increase and decrease the fuel bed brightness - 1 bar is the dimmest setting, 5 bars is the brightest setting.

**On screen dL.0 = No illumination**

**On screen dL.1 = Red**

**On screen dL.2 = Orange**

**On screen dL.3 = Yellow**

**On screen dL.4 = Green**

**On screen dL.5 = Light Blue**

**On screen dL.6 = Dark Blue**

**On screen dL.7 = Violet**

**On screen dL.8 = White**

**On screen dL.9 = Multi-colour change**

### **Button 10: Heater Mode**

Press to cycle through the heat output options.

**1 press: Co.A = Cool blow setting**

**2 press: H.Lo = Low heat setting**

**3 press: H.HI = High heat setting**

**4 press: no.H = No Heat**

## OPERATION CONTINUED

Whilst in heater mode after selecting low or high heat setting, press the – and + buttons to select the temperature you want the room to reach. Note: if the room temperature is already higher than the temperature selected, the heater will not activate. To switch between °C/°F hold down the – and + buttons for 3 seconds.

Open Window Detection is an innovative eco feature that detects a rapid drop in room temperature caused by an open window. The warning word "OPn" will be displayed on the screen and the heater will be turned off. If the room temperature rises or the remote control is operated manually, the heater will return to its normal working state.

### Button 11: Sound Effect

Press to open the open the sound effect menu.

**1 press: S.on = Sound effect on**

**2 press: no.S = Sound effect off**

Whilst in the sound effect menu, press the plus and minus buttons to increase and decrease the volume - 1 bar is the quietest setting, 5 bars is the loudest setting.

### Button 13: Ambient Lighting (if appliance is fitted with optional Ambient Lighting Kit)

Repeatedly press to turn on ambient lighting and cycle through the different colour options.

### Button 14: Eco Mode **ECO**

Press to activate Eco mode. This mode will reduce the brightness of all lighting modes and limit the heat output to low setting, resulting in reduced energy consumption. Press the button a second time to exit Eco mode.

## APP CONTROL

Visit your device app store (iOS or Android) to download the TUYA SMART APP. Once installed follow the procedure below to pair the device with your appliance.:

Step 1. Start the app and click "Add Device" on screen. Select "Small Home Appliance" from the list, then select "Heater (Wi-Fi)".

Step 2. Ensure the appliance is powered on then press and hold the  button on the appliance until you hear 3 beeps. At the same time the button will flash and the fuel bed will flash.

Step 3. Follow the instructions on the app to input your home network details. Note, your device must also be connected to the same home network you wish to connect the appliance to.

Once connected you can fully control your appliance and also programme a weekly timer that features Adaptive Start Control – a smart home device that gauges the current temperature of the room and anticipates the time required to heat it to a desired temperature. When in weekly timer mode, the appliance will automatically determine the time to turn on the heater to ensure that the set temperature is met at the time required (up to 45 minutes prior to the set time).

For further guidance, please consult the section 'App Connection Guide' on page 15.

## IMPORTANT INFORMATION – AMBIENT LIGHT KIT

This stove can be used with an LED mood lighting kit approved by Vision Fires – The Solus Ambient Light Kit (available from your retailer). Other, non-approved LED light kits must not be used as they may damage the appliance and invalidate the warranty. The Solus Ambient Light Kit must only be used when connected directly to the appliance using the pre-fitted connecting adaptor (this can be found at the underside of the stove at rear of the heater enclosure, next to the mains plug socket). The Solus Ambient Light Kit must not be adapted to be operated independently of the appliance, such as modifying it to run on an independent 240v supply.

The Solus Ambient Light Kit is supplied as a 3m LED strip with adhesive tape backing, and a 2m extension cable (not illuminated).

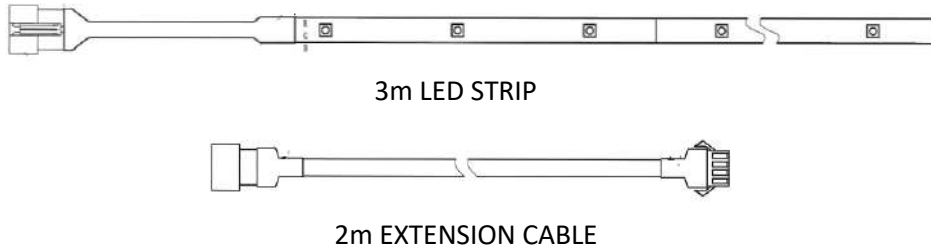
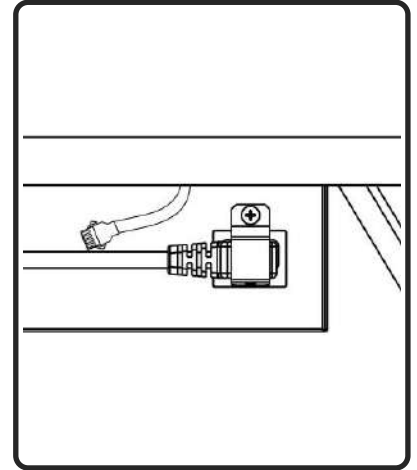

## CLEANING & MAINTENANCE

**IMPORTANT: ALWAYS DISCONNECT THE STOVE FROM THE POWER SUPPLY AND ALLOW TO COOL BEFORE CLEANING.**

Any repairs or maintenance should only be carried out by a suitably qualified competent person.

The appliance should be occasionally cleaned using a dry cloth. Do not use detergents, abrasive cleaners or furniture polish.

To clean the glass, use a lightly damp cloth and ensure any moisture is dried fully using a lint free cloth.

Ensure that the heater vent is kept dust free by occasionally vacuuming the area using a brush attachment.

## TROUBLESHOOTING

### Resetting the Thermal Cut Out

The appliance is fitted with an Electronic Safety Control (E.S.C.). This is a safety device which switches off the fire if, for any reason, the appliance overheats, e.g. when covered. If the heater stops operating while the flame effect

## TROUBLESHOOTING CONTINUED

continues working normally, this indicates that the E.S.C. is in operation. The E.S.C. can only be reset after the appliance has cooled down and the appliance has been reset. Re-setting of the E.S.C. procedure is as follows:

1. Switch off the appliance (Manual On/Off switch) and leave it off for approximately 10-15 minutes.
2. Remove any obstruction to the fan heater outlet or fan blades etc. Make sure that the power supply is disconnected with the plug socket outlet while doing this.
3. Switch on the appliance and the E.S.C. will be reset.
4. Ensure that the appliance is functioning correctly. If the E.S. Control operates again, the appliance should be checked by a competent electrician.

PROBLEM	POSSIBLE CAUSE	SOLUTION
Appliance will not turn on.	Problem with power supply.	Check that the appliance is plugged in to the power supply and switched on.  Check and replace fuse in the plug if necessary.  Check that the main power switch on the appliance is turned on.
Remote control does not work.	Batteries have expired.	Replace batteries.
	Remote has de-synched with appliance.	Ensure that the appliance is turned on. Re-synch the remote by pressing the - button and the + button at the same time and holding for 3 seconds.
No heat	Incorrect thermostat setting.	Increase the desired temperature higher than the current room temperature.
	Overheating may have engaged the E.S.C. feature.	See above for reset procedure.
Heat turns off before desired temperature is reached.	Open window detection has activated.	Check that any windows in the room are closed.

## WARRANTY

Vision E-Line appliances come with a standard 1-year warranty (parts & labour) when purchased through an authorised dealer. This can be extended for free to two years (parts only for year 2) by registering your appliance within 60 days of purchase.

Visit [www.visionfires.co.uk/warranty](http://www.visionfires.co.uk/warranty) to register your appliance, activate the free warranty extension, or to see details about the 6 year Premium Protect warranty package.

## APP CONNECTION GUIDE

To connect your appliance to the Vision E-Line Solus app you will need the following:

- ✓ A device running android or ios such as a tablet or smart phone
- ✓ Network within range of the fire
- ✓ Valid email address, which you are able to access for verification

### STEP 1 – DOWNLOAD THE TUYA SMART APP & CREATE ACCOUNT

Download the Tuya Smart app from your app store

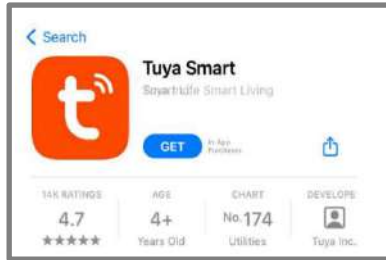

Once downloaded, the TUYA icon will appear on your device's home screen, you can now open this app by tapping the icon.

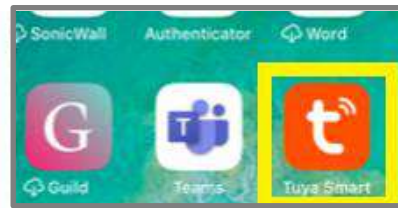

Follow the directions in the app to create an account. A valid email address will be required to complete the account set up process. Once your account is set up you will receive a number of permissions, please follow the on screen prompts.

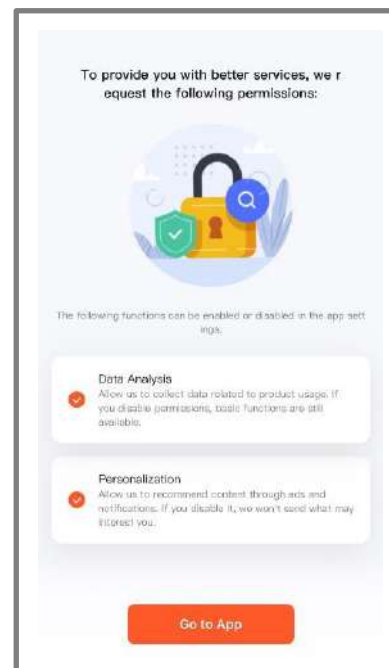

## APP CONNECTION GUIDE

### STEP 2 – CONNECT YOUR APPLIANCE TO THE APP

Now you can begin the process of connecting your appliance to the app. At the home screen press the 'Add Device' button.

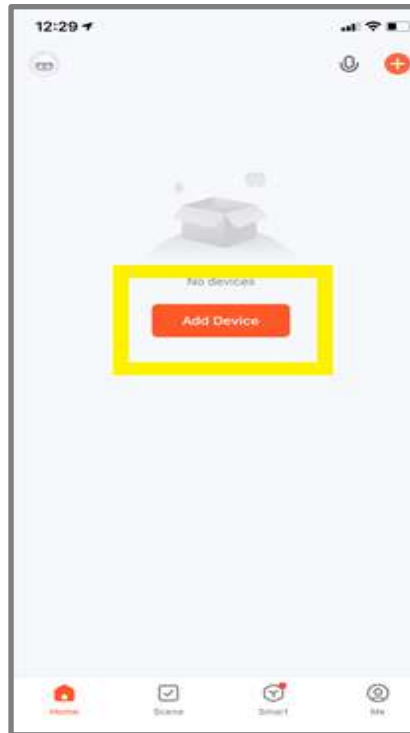

Once the password has been entered you will be presented with a checklist to ensure trouble free connection of your appliance to the network. You may also be asked to allow location permissions, please read, and follow the on-screen information.

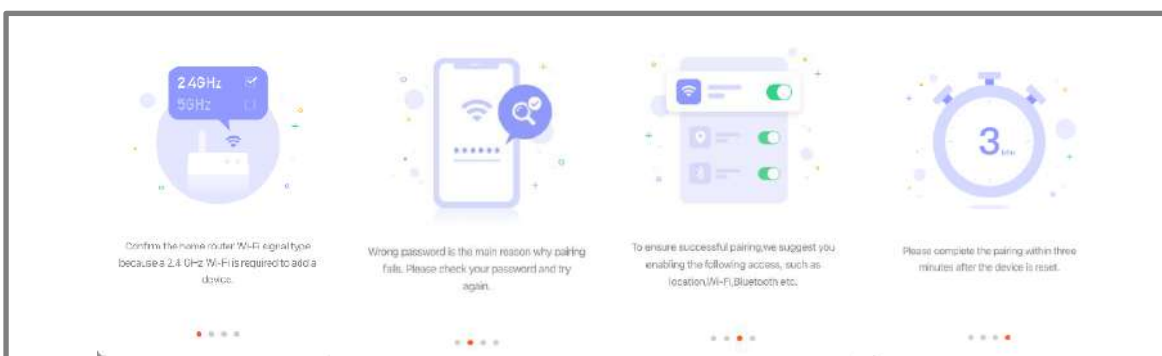



## APP CONNECTION GUIDE

After you have gone through the permissions you will then need to choose which device to pair, please select **small home appliances** from the menu as shown below:



Now from the list of small home appliances select **Heater (Wi-Fi)**. This will then prompt you to enter your Wi-Fi password, ensure the correct network is selected enter your Wi-Fi password then press the next button.

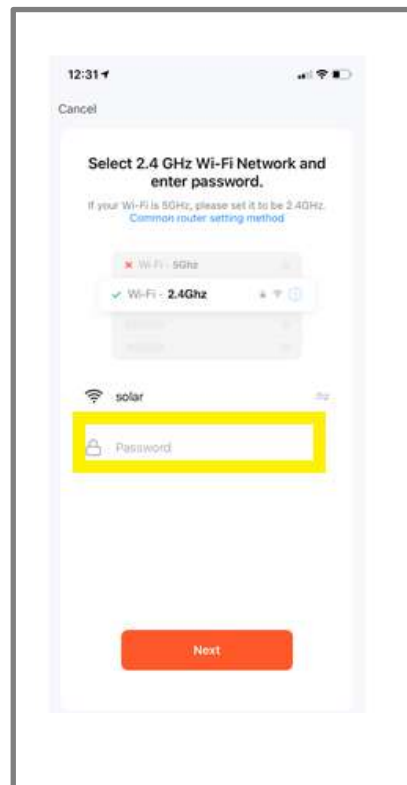
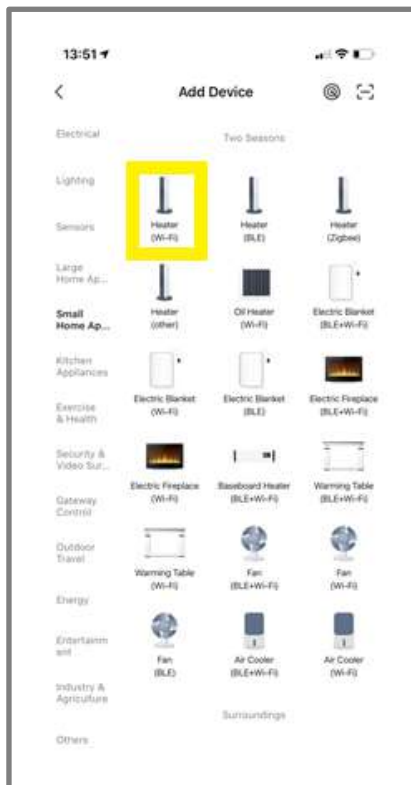

## APP CONNECTION GUIDE

Now the app will prompt you to reset the device. This is referring to placing your fire into pairing mode. Before tapping next you will need to put your appliance into pairing mode. Ensure the fire is switched on then press and hold the Wi-Fi button on your fire, located on the panel directly behind the stove door as shown below, until fuel bed flashes red.

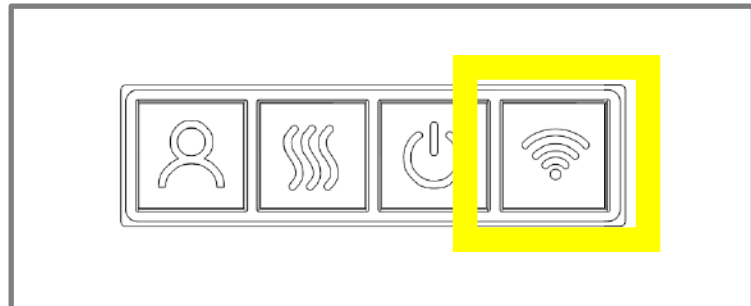
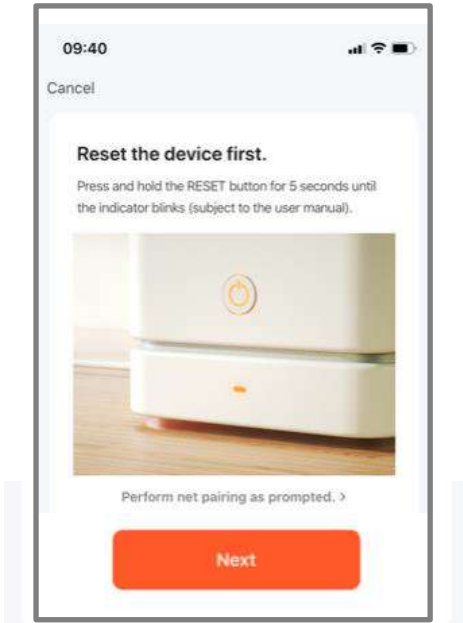

Once the fire is placed in pairing mode with a flashing red fuel bed, tap the next button on the app and choose the Blink Quickly button this will then begin to search for the fire, when it has successfully paired the fire fuel bed will display a solid green colour.

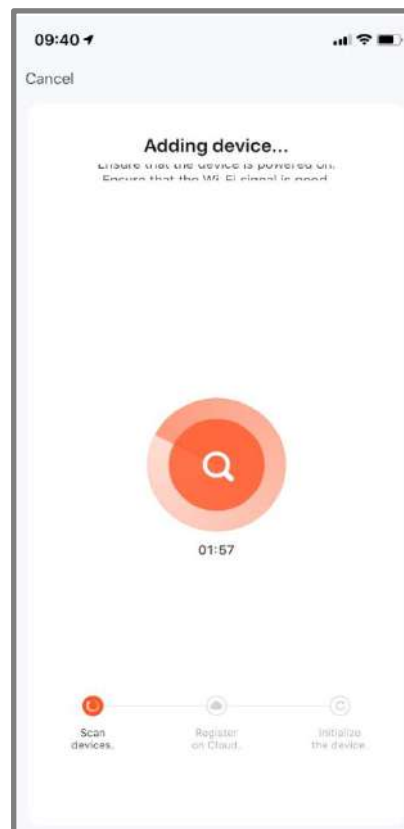
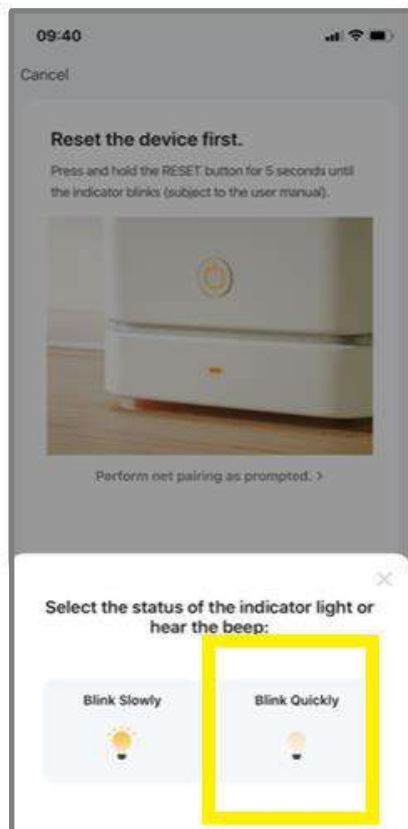

## APP CONNECTION GUIDE

Please note, the fire fuel bed colour indicates the status of the fire when first initiating the pairing the fuel bed will flash red. Once successfully paired the fuel bed will display green. If a flashing blue fuel bed appears check your connection and repeat the pairing procedure.



Flashing Red – In pairing

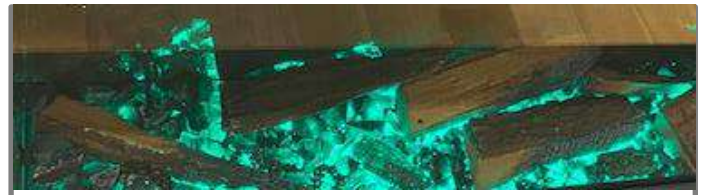

Solid Green – Successfully paired



Flashing Blue – Failed Pairing

## STEP 3 – SUCCESSFUL PAIRING

On successful pairing you can now use the Vision E-Line app to control your appliance. Your appliance will now be listed as a device in the Tuya home screen. Select the appliance to begin using the Vision E-line app. To turn the fire on use the power button as highlighted in the illustration below.

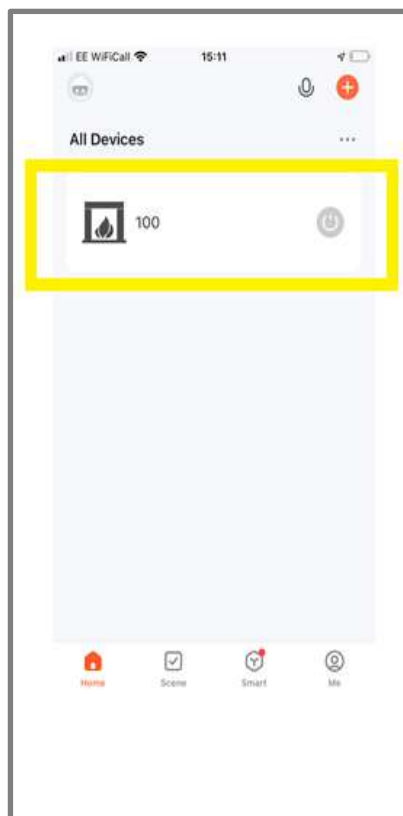

## APP CONNECTION TROUBLESHOOTING

If you have trouble connecting, please check:

- Ensure your appliance is in standby mode
- Your appliance is in range of the network
- Your smartphone/tablet is connected to your home network
- Ensure the latest version of the app is installed on your phone or tablet
- Check your network has a good signal strength

If you are still experiencing issues, please uninstall the app from your device and reinstall then repeat the above steps.

### Advanced Wi-Fi Router Guidance

Wireless transmissions get weaker as you get further from your wireless router, they can also be disrupted by general building fabrics, such as metal framework, walls & floors.

For the best possible connection to your Solus appliance, the location of your wireless router in relation to your appliance is key:

- If there are certain areas of your home where you find your signal drops, it may be due to a blockage.
- Large objects can often obstruct or interfere with a wireless connection, so it's best to keep your router off the ground and away from larger items
- Steer clear from putting your router behind the sofa, inside a cabinet or behind a door - although it looks tidy, if you are experiencing an issue this could be the cause a problem
- You should also keep electronics such as microwaves, lamps, speakers, TVs and monitors as far away from the router as possible

**If issues are encountered when trying to connect your appliance, our best advice would be to follow the below:**

1. Check the location of the appliance in relation to the wireless router, are there any objects that may be causing a problem with the signal?
2. Check if you are experiencing the same connection problem across other devices, you can do this by checking their Wi-fi status. Typical devices to be checked would be your mobile phone, tablet, laptop, or even your TV.
3. Try adding a new device to your wireless network – this will verify that the wireless password & SSID are correct.
4. Are you using wireless extenders? If so, turn off all wireless extenders and add try adding a new device (a mobile phone for example) in the same location as your wireless router. This confirms that your Wireless router is accepting new devices without issue.
5. You could also try resetting the wireless router.

### Tips and advice:

If the appliance is installed out of the range of your wireless network, the Wi-Fi signal will not be detected by the appliance. It may be too far away from your router. You may need to purchase a signal booster to extend the range of your home network. You can purchase a Wi Fi booster form any computer store, online or an electrical retailer.

### How do I know if my Wi-Fi signal is strong enough or if the appliance is out of range?

Simply stand in front of the appliance holding the device in close proximity to the control panel, you will find this on the front of the appliance. By using an existing device, that is already connected to the wireless network, this could be a phone or tablet, and then see if the Wi-Fi indicator shows that you have signal? If the signal strength is not full, it may indicate connectivity issue. If they are greyed out or only 1 or 2 bars are showing, then the signal strength of your home network will need boosting, in order for your Tuya app to control the appliance.

## APP CONNECTION TROUBLESHOOTING

### 2.4 GHz Wi-Fi NETWORK

If you are connecting your appliance to the app, you must connect your Tablet or Phone to your router's 2.4 GHz band before the setup process. Many routers broadcast Wi-Fi networks in both 2.4 GHz and 5 GHz bands. Your appliance will only connect to a 2.4 GHz Wi-Fi network

When connecting your appliance to your Wi-Fi network, ensure that you select the SSID that indicates it is a 2.4 GHz network. This is typically indicated by a 2, 2.4, or 2G at the end of the SSID (network name).

#### **If you have both 2.4 GHz and 5 GHz Wi-Fi networks:**

- Your 2.4 GHz network name or SSID might have a 2, 2.4, or 2G at the end
- Your 5 GHz network name or SSID might have a 5 or 5G at the end

#### **If your router uses the same Wi-Fi network name or SSID for both 2.4 GHz and 5 GHz Wi-Fi bands:**

Some Wi-Fi routers will only have one Wi-Fi network name that is used for both 2.4 GHz and 5 GHz Wi-Fi bands. If you are having trouble connecting and your Wi-Fi network name doesn't indicate whether it's 2.4 GHz or 5 GHz, please consider the following.

- Routers can use the same network name or SSID to broadcast both 2.4 GHz and 5 GHz Wi-Fi networks. If your device is connected to a mesh network, your solus fire will not be able to connect to the 5 GHz band, so it will automatically connect to the 2.4 GHz band
- For networks that have the same SSID (network name). for 2.4/5 GHz: Try temporarily disabling 5 GHz in the router settings
- Try opening your router settings and look for a 2.4 GHz Wi-Fi network that your device can connect to. If you need help with this, contact your Internet Service Provider (ISP), and ask for help connecting your device to a 2.4 GHz Wi-Fi network

**Visit [www.visionfires.co.uk](http://www.visionfires.co.uk) for the latest information.**





Electrical appliances should not be disposed as household waste. Separate collection facilities should be used in the disposal of electrical appliances. Contact your local government for information about the available collection systems. If electrical appliances are disposed of in landfills or dumps, hazardous substances can leak into the groundwater and get into the food chain, damaging your health and well-being.



This fire complies with the Safety Standards EN 60335-1 and EN60335-2-30 which covers the essential requirements of the Low Voltage Directive 2014/35/EU and the EMC standards EN55014-1; EN55014-2; EN61000-3-2 and EN61000-3-3 which covers the essential requirements of the European Electro Magnetic Compatibility 2014/30/EU, and the RED standards EN300220-2, EN30148 9-1, EN301489-3 and EN6247 which covers the essential requirements of the European Radio Equipment Directive 2014/53/EU.



This fire complies with the Safety Standards BS 60335-1 and BS 60335-2-30 which covers the essential requirements of the Electrical Equipment (Safety) Regulations 2016 (S.I.2016/1101) and the EMC standards BS 55014-1; BS 55014-2; BS 61000-3-2 and BS 61000-3-3 which covers the essential requirements of the Electro Magnetic Compatibility Regulations 2016 (S.I.2016/1091).and the RED standards BS300220-2, BS301489-1,BS301489-3 and Bs6247 which covers the essential requirements of the European Radio Equipment Regulations 2017.

THE  
**GALLERY**  
COLLECTION

[www.thegallerycollection.co.uk](http://www.thegallerycollection.co.uk)

